

Arendal A

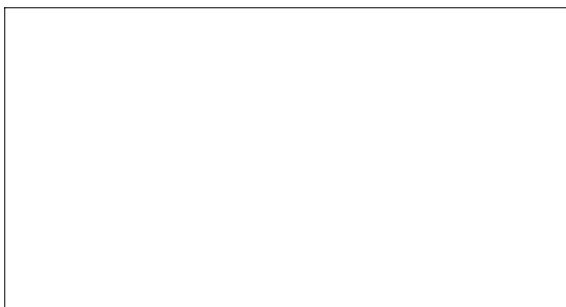

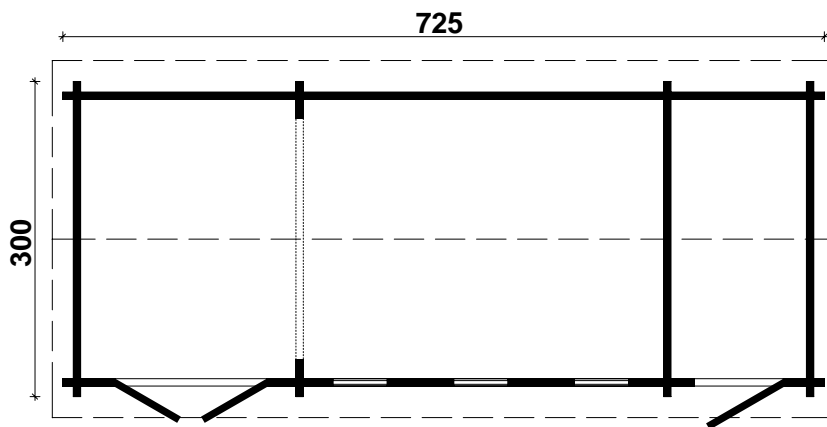







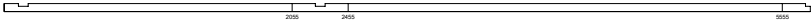









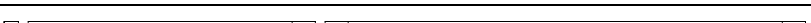
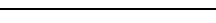



Byggyta: 300 x 725 cm

Yttermått: 280 x 705 cm - Väggtjocklek: 70 mm



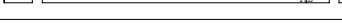



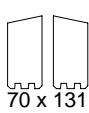
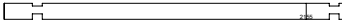
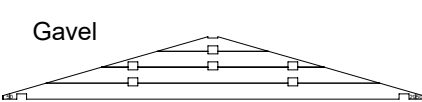
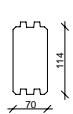

OBS! Alla mått är ungefärliga.

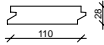
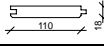
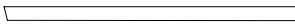
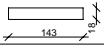
Arendal

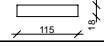
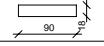
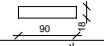
| Nr. | Beskrivning | Profil mm | Längd mm | Antal |
|-----|--|---|----------|--------|
| 001 | Grundreglar |  | 2770 | 3 |
| 002 | | | 5535 | 6 |
| 003 | | | 1275 | 6 |
| 004 | | | 470 | 2 |
| 005 |  |  | 5755 | 1 |
| 006 |  | | 1495 | 1 |
| 007 |  | | 500 | 1 |
| 008 |  | | 4070 | 1 |
| 009 |  | 390 | 1 | |
| 010 |  |  | 3000 | 58 |
| 011 |  | | 2255 | 9 |
| 012 |  | | 4995 | 9 |
| 013 |  | | 5755 | 8 |
| 014 |  | | 1495 | 8 |
| 015 |  | | 350 | 34 |
| 016 |  | | 500 | 17 |
| 017 |  | | 390 | 17 |
| 018 |  | | 630 | 17 |
| 019 |  | | 620 | 17 |
| 020 |  | | 630 | 34 |
| 021 |  | | 550 | 2 |
| 022 |  | | 5855 | 5 |
| 023 |  | | 1595 | 5 |
| 024 | | -- | -- | |
| 025 | | -- | -- | |
| 026 |  | 5055 | 1 | |
| 027 |  | 2395+14 | 1 | |
| 028 |  |  | 5855 | 1 |
| 029 |  | | 1595 | 1 |
| 030 |  |  | 5055 | 4(2+2) |
| 031 |  | | 2395+14 | 4(2+2) |
| 032 | | | -- | -- |
| 033 | | | -- | -- |
| 034 | Gavel  |  | 3000 | 4 |
| 035 | Pardörr ca. 1425 x 1955mm - 70 mm ISO | | | 1 |
| 036 | Enkeldörr ca. 840 x 1955 mm - 70 mm ISO | | | 1 |
| 037 | Enkelfönster ca. 515 x 1890mm - 70 mm ISO | | | 3 |

Arendal

| Nr. | Beskrivning | Profil mm | Längd mm | Antal |
|-----|--|---|------------|----------|
| 038 | Golvbrädor |  | 2657 | 63+1 |
| 039 | Takpapp | | 7550 | 5 |
| 040 | Takbrädor |  | 1770 | 136+2 |
| 041 | Gaveldel  |  | 1810 | 4 |
| 042 | Gaveldel  |  | 1810 | 4 |
| 043 | Gaveländbräda |  | 1810 | 4 |
| 044 | Vindskiva |  | 3725 | 4 |
| 045 | Vindskiva |  | 3725 | 4 |
| 046 | Romb |  | | 2 |
| 047 | Plugg | | | 60 |
| 048 | Gängad stång | ∅ 10 | 2250 | 8 |
| 049 | Mutter, skriva | | | 16 |
| 050 | Spik 2,2 x 50 ; 2,5 x 70 | | | 1 Beutel |
| 051 | Takpappsspik 3,0 x 15 | | | 1 Beutel |
| 052 | Skruvar 4,0 x 40; 5,0 x 100 | | | 1 Beutel |
| 053 | Lister |  | ca. 25,0 m | |
| 054 | Slagbitar | | 300-400 | |

Arendal

Grund

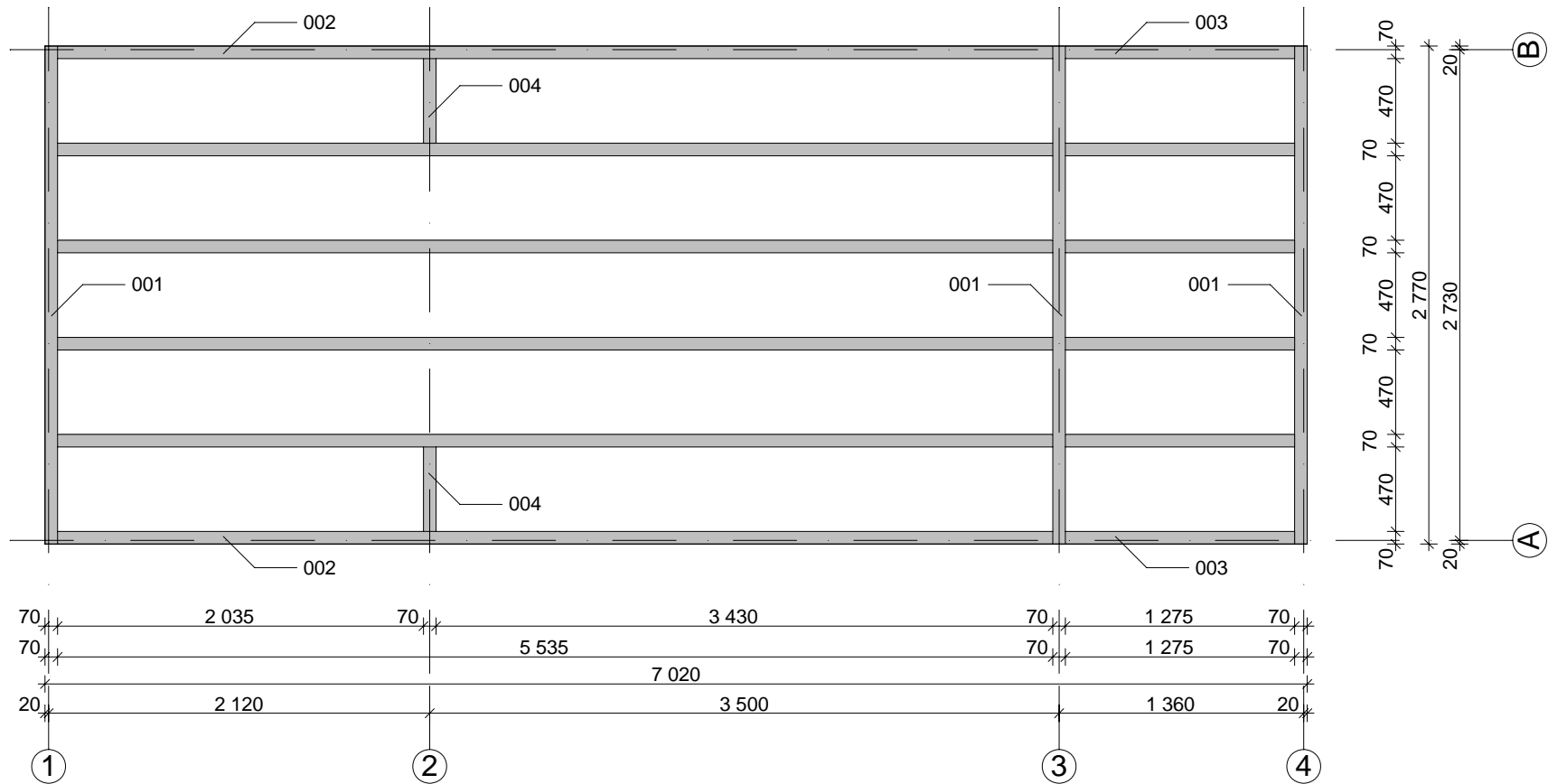

Arendal

Markplan

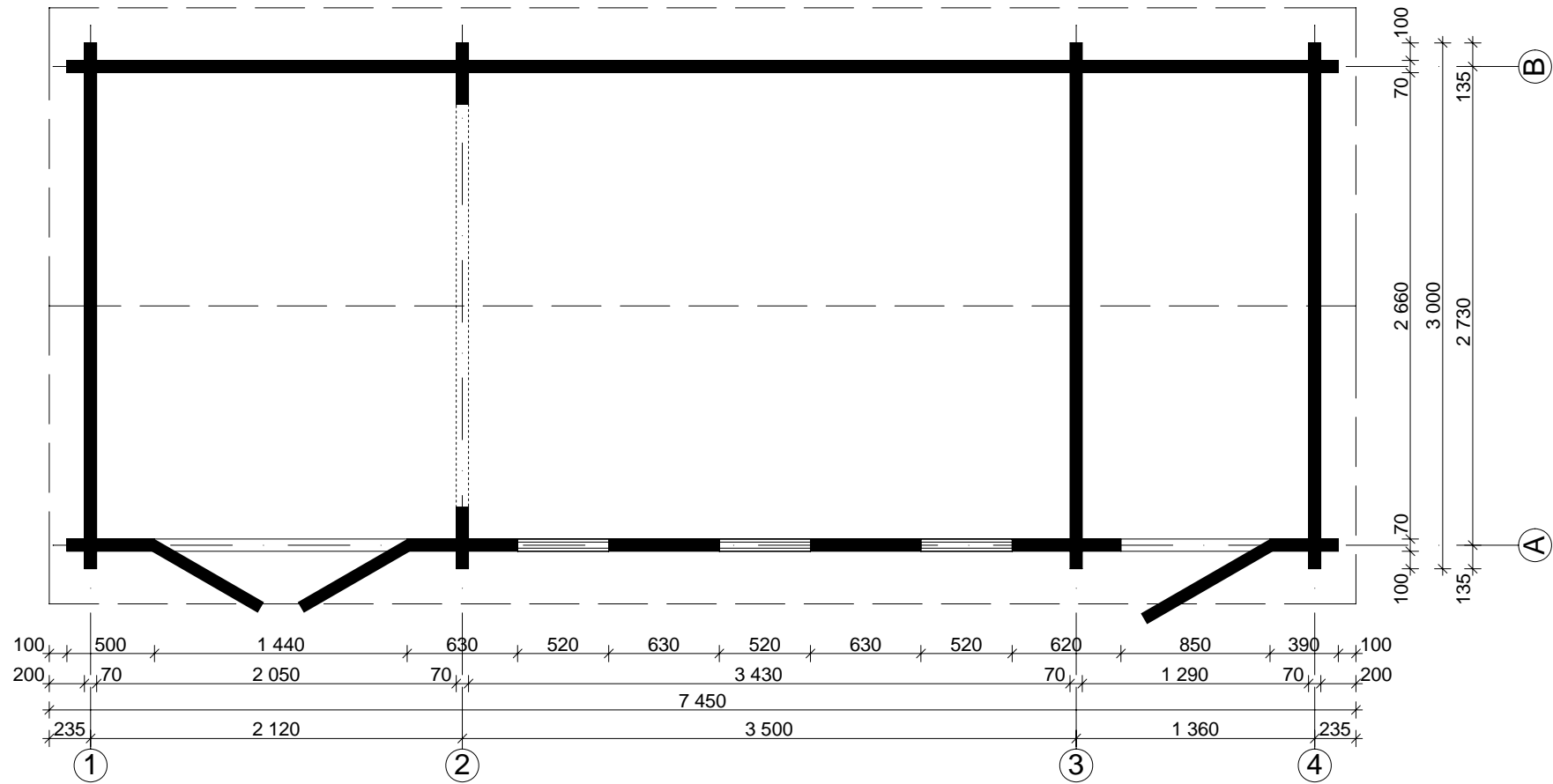

Arendal

1, 3, 4

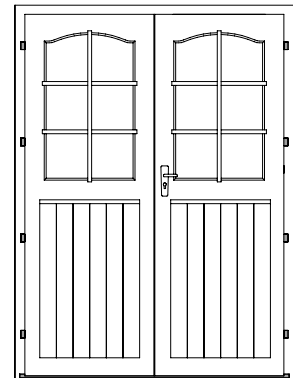
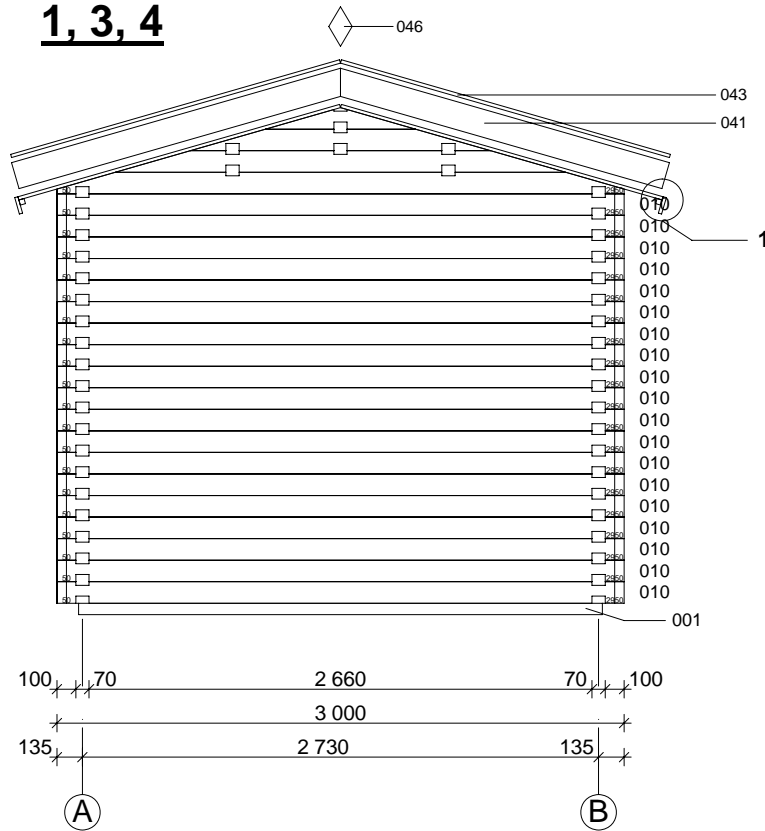

Doppeltür
70 mm ISO
1425 x 1955 mm
1 st.

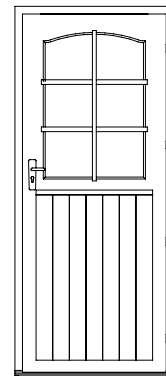

Einzeltür
70 mm ISO
840 x 1955 mm
1 st.

2

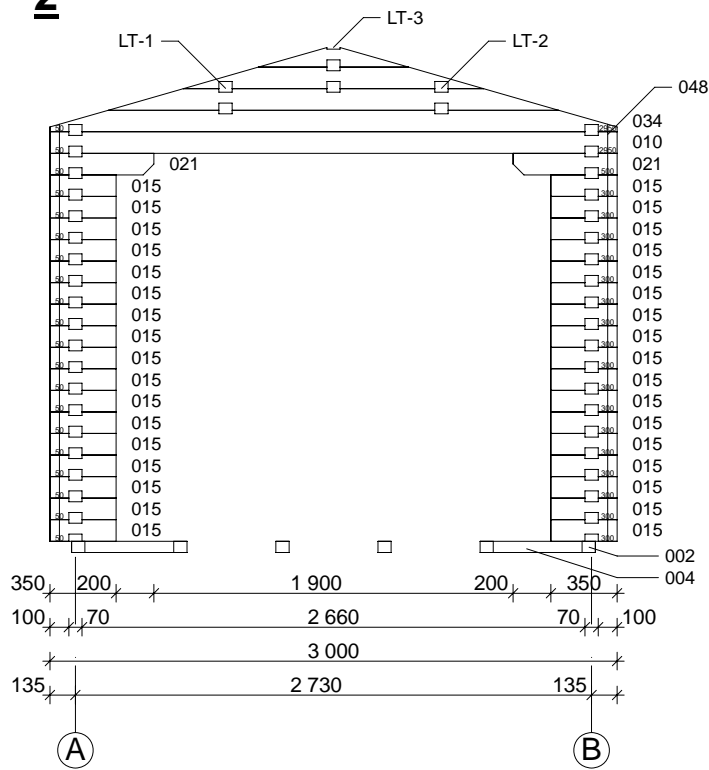

Einzelfenster
70 mm ISO
515 x 1890 mm
3 st.

Arendal

A

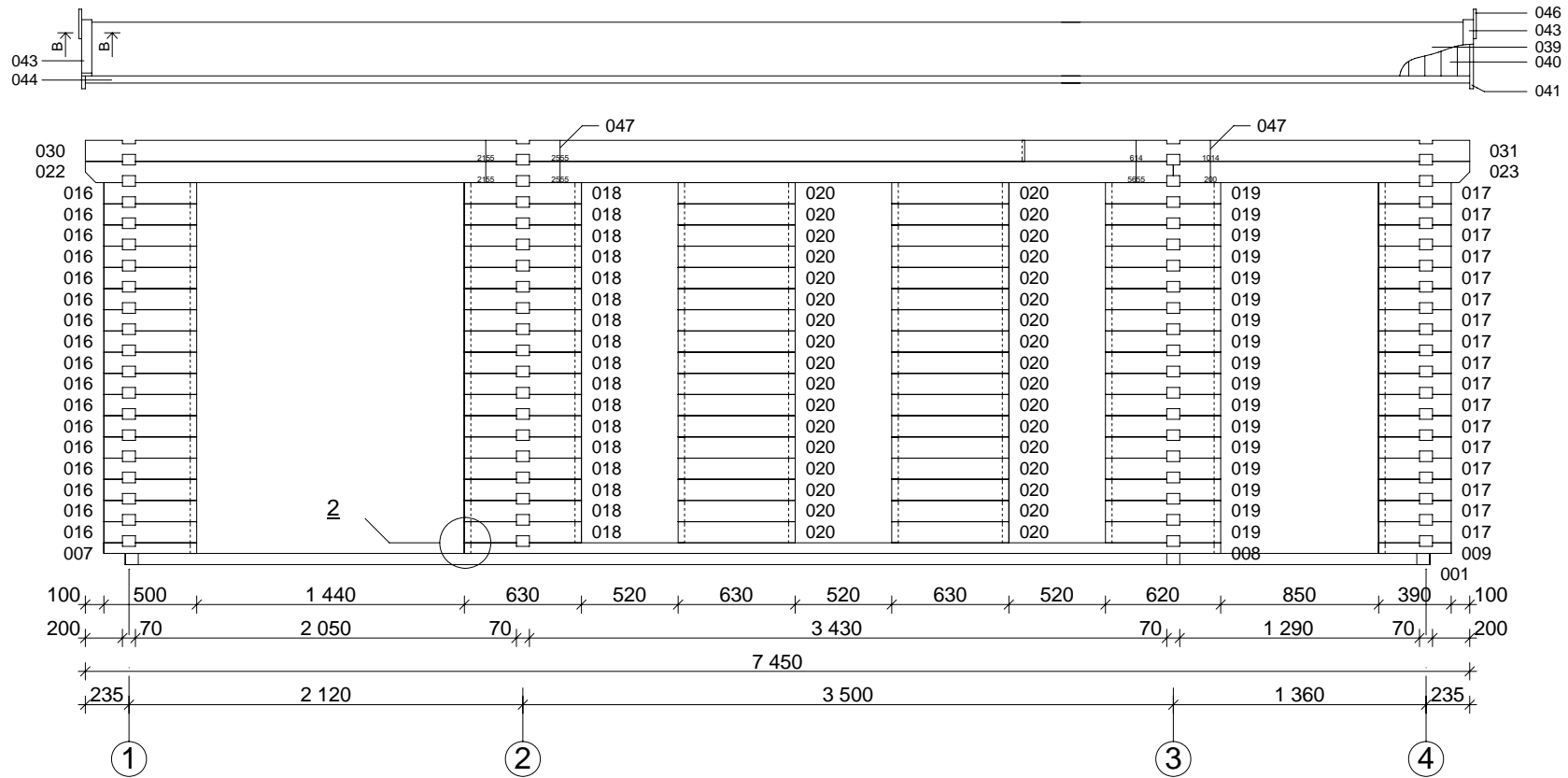

A-A

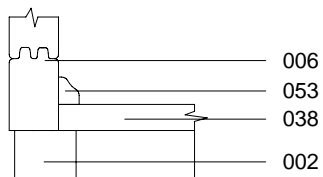

B-B

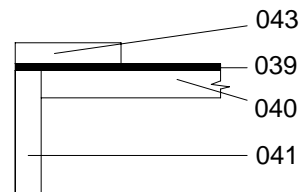

Arendal

LT-1

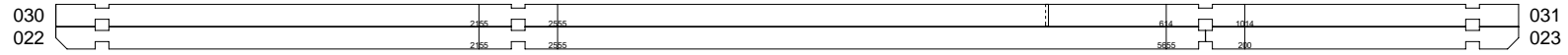

LT-2

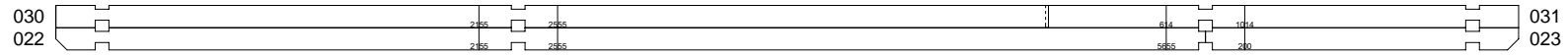

LT-3

