

Erik

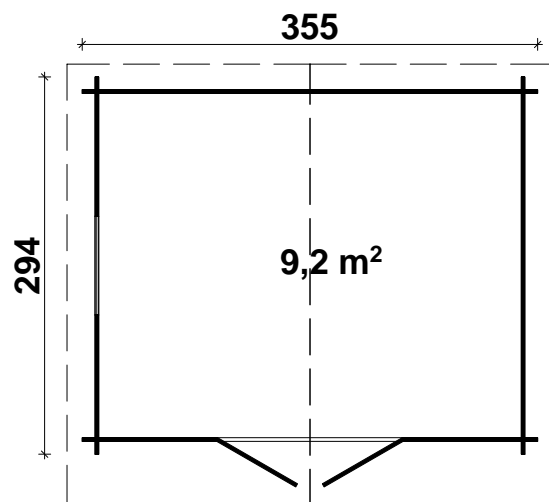









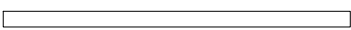
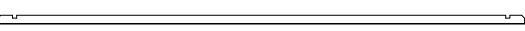

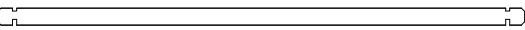

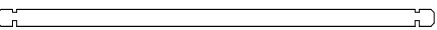
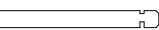

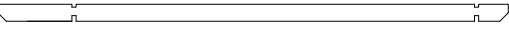
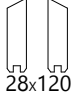
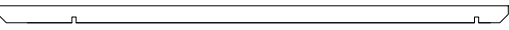
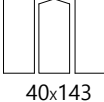
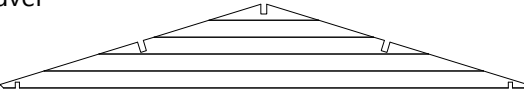

Byggyta: 355 x 294 cm

Yttermått: 335 x 274 cm · Väggtjocklek: 28 mm

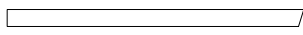

OBS! Alla mått är ungefärliga.

Specifikation - Erik 28 mm

Nr	Description	Profil mm	Längd mm	Antal
1	Grundbjälke 	□ 45x70	3343	2
2	Grundbjälke 		2643	10
3			3553	2
4			3553	16
5			2943	21
6			1087	18
7			1057	32
8			3143	2
9			--	--
10			--	--
11			--	--
12			3443	2
13	Takbjälke 		3443	3(2+1)
14	Takgavel 		3553	2
15	Dörr ca. 1425 x 1775 mm		+ 	1/2
16	Fönster ca. 765 x 990 mm		+ 	1/1
17	Takpapp			--
18	Takbrädor	Vers. 1 >		--
		Vers. 2 >		1960
19	Golvbrädor	Vers. 1 >		--
		Vers. 2 >		3295
20	Takfotsbräda 	18x115	2000	4
21	Fotplåt	16x35	2000	4
22	Vindskivor	18x90	3443	2
23	Vindskivor	25x38	3443	2
24	Romb 			2
25	Lister			ca. 12 m
26	Skruvar 4,0 x 40			1 packet
27	Spikar 2,2 x 50			1 packet
28	Stormbräda		1900	4
29	M 8 x 60, Mutter , Bricka			12
30	Takpappsspik 2,8 x 15			-
31	Slagbitar		300-400	

Erik

Grund

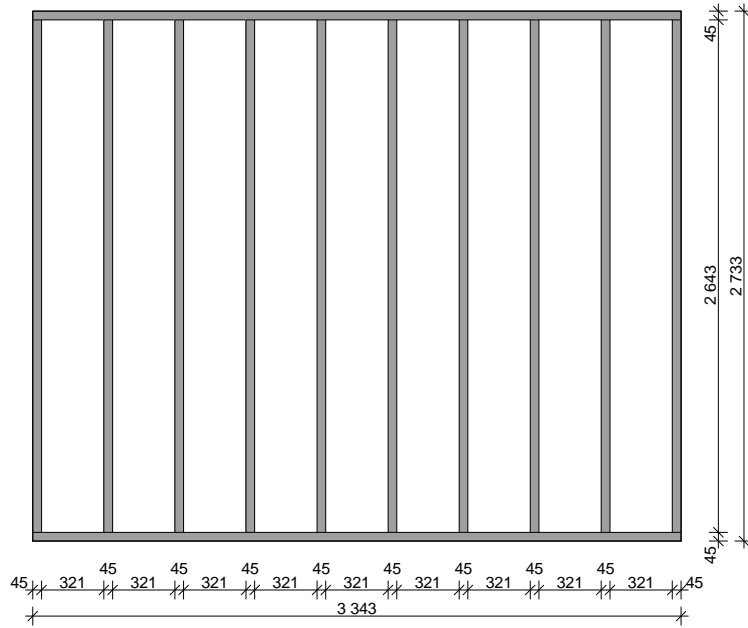

Markplan

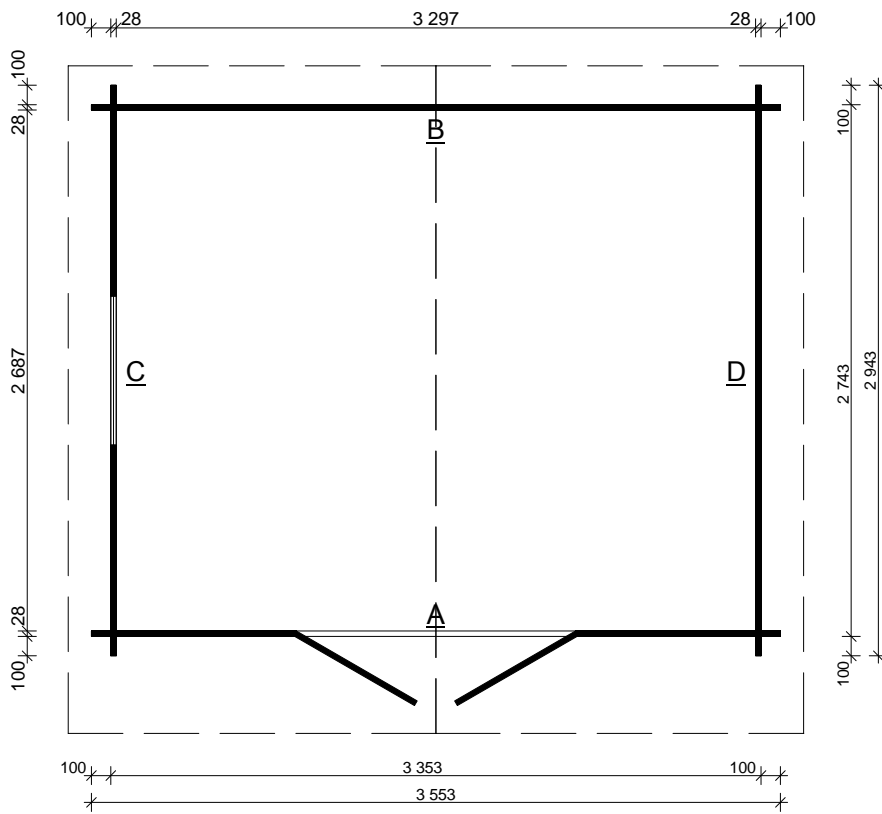

Erik

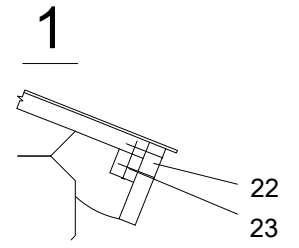
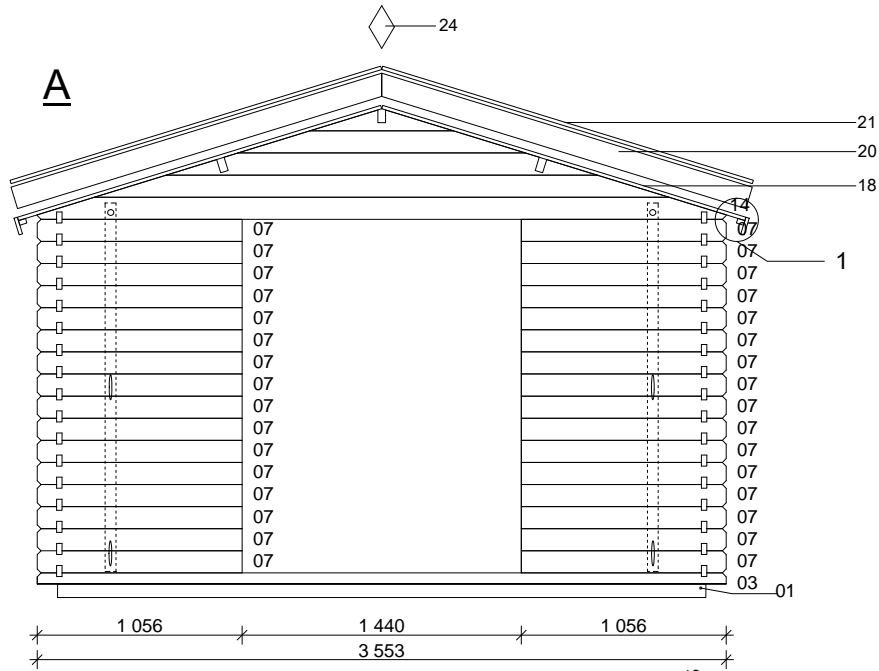

A-A

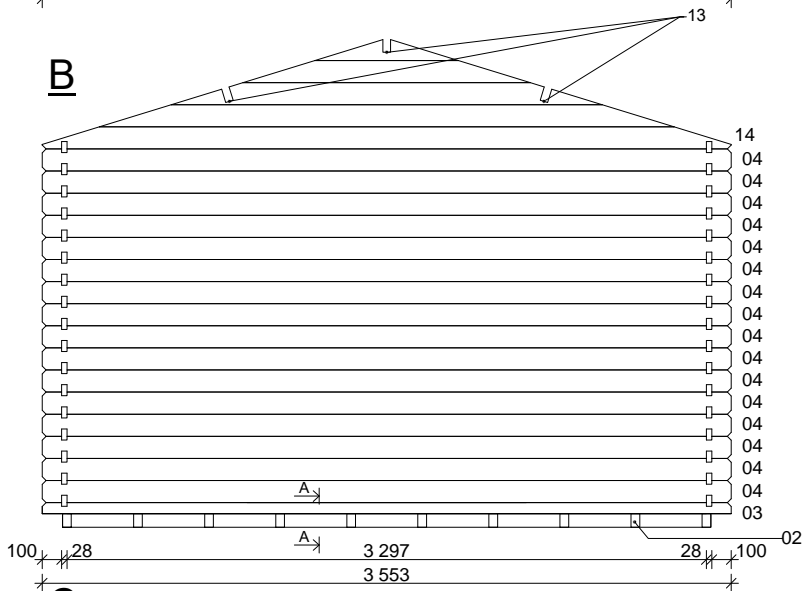
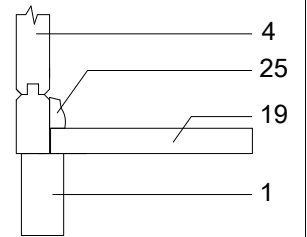

B-B

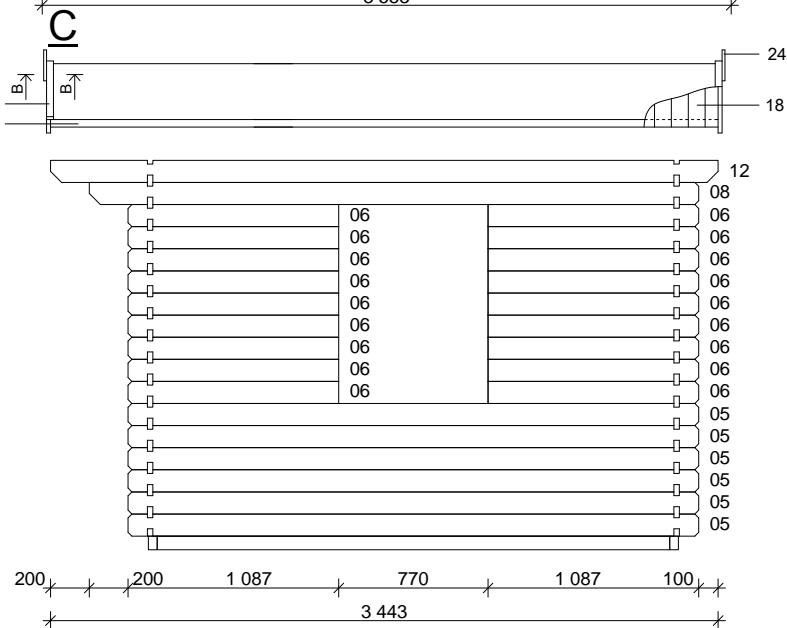
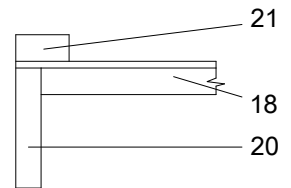

Erik

