

*Hedda B*  
1/6

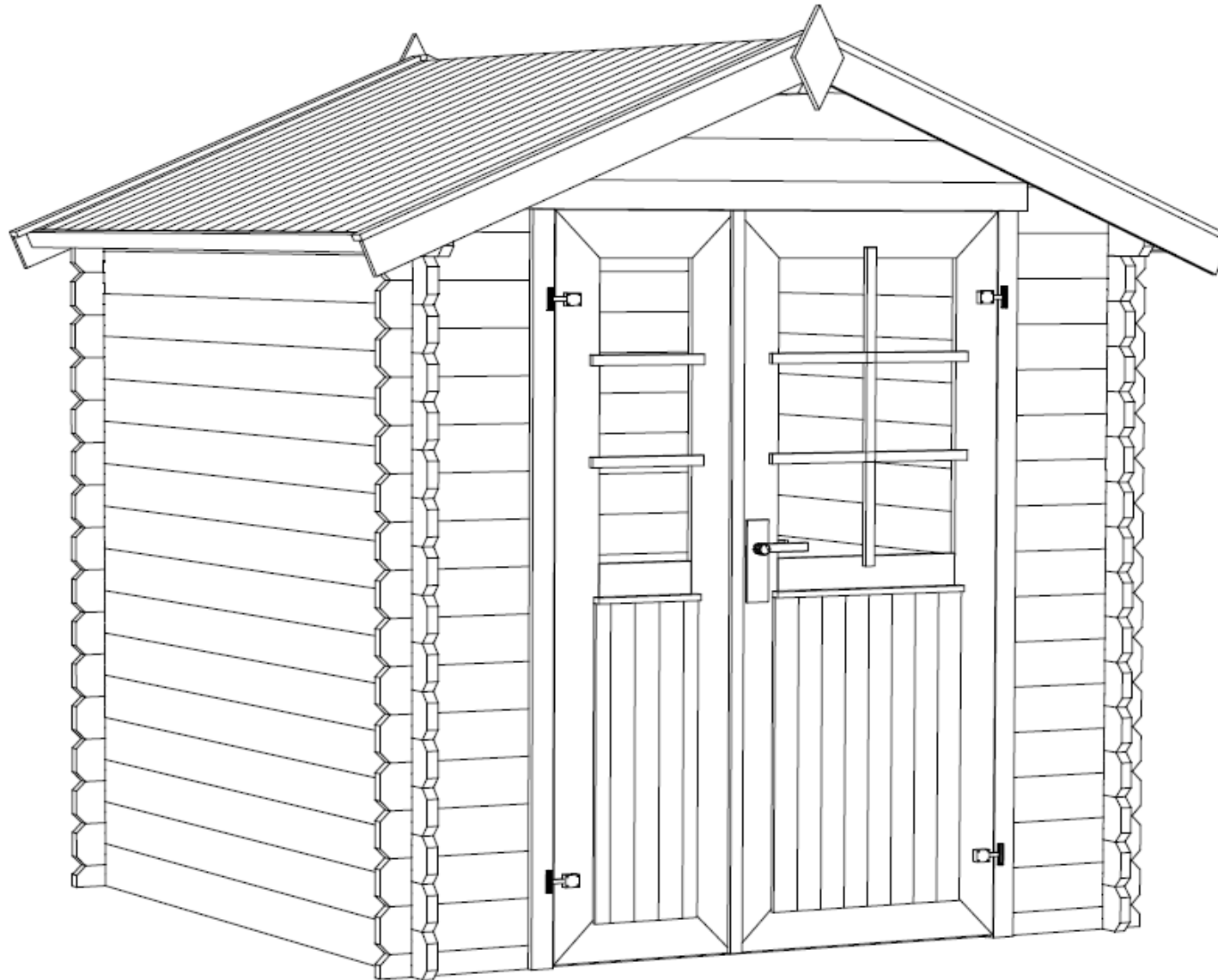

30.03.2015

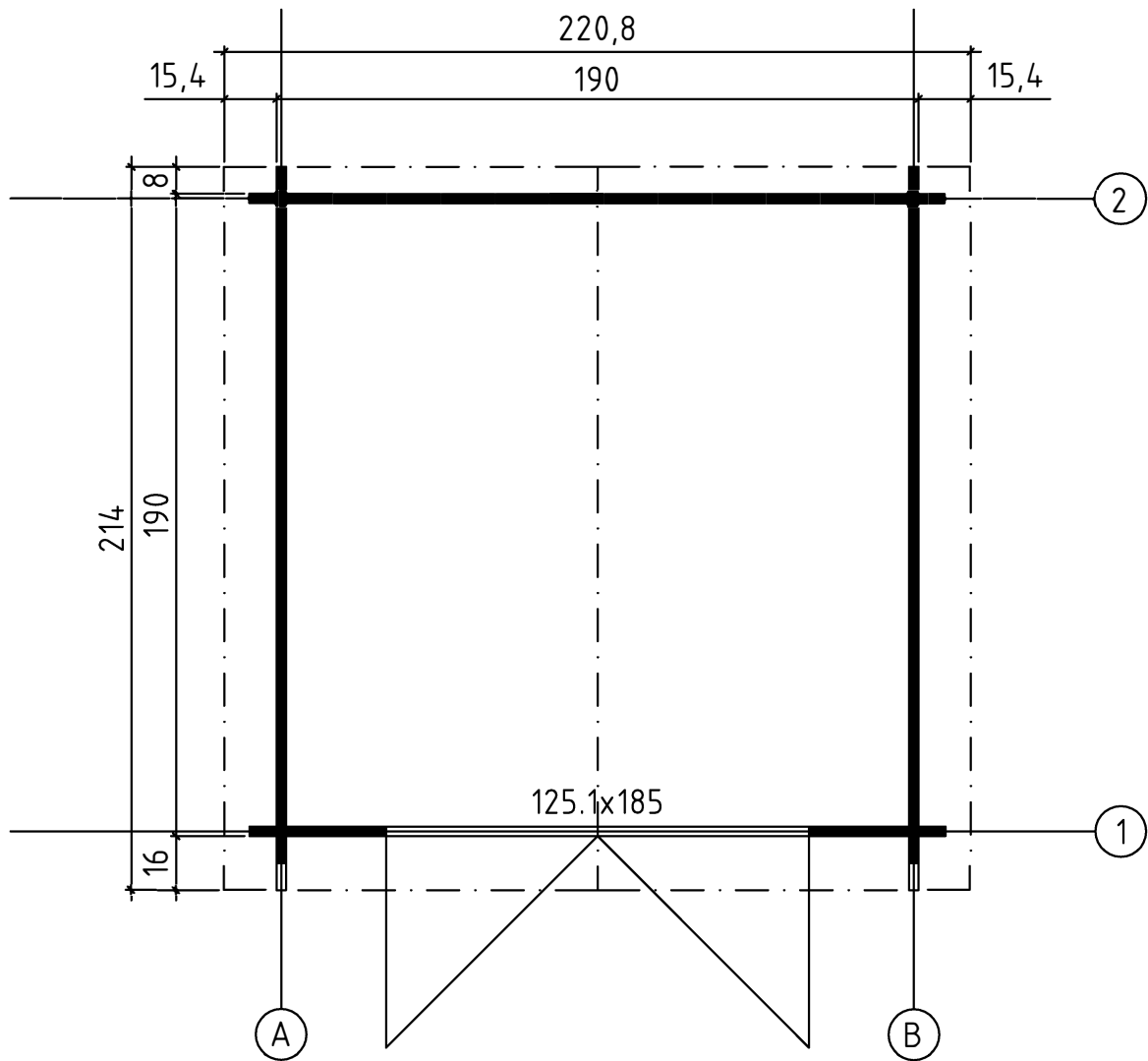



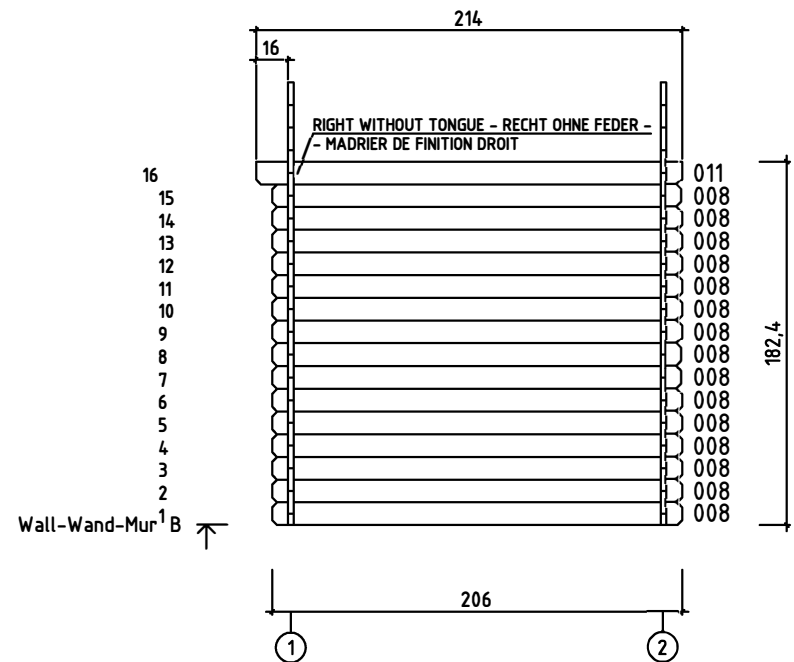
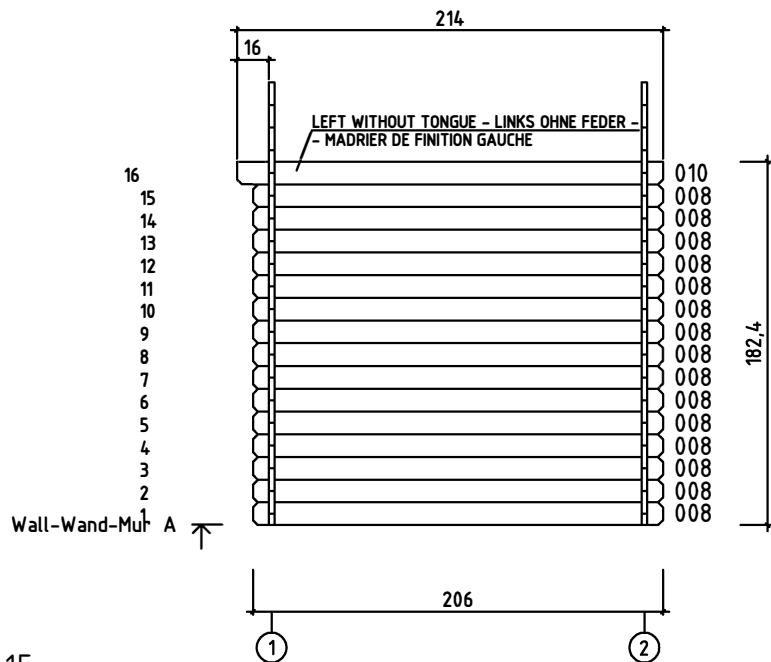
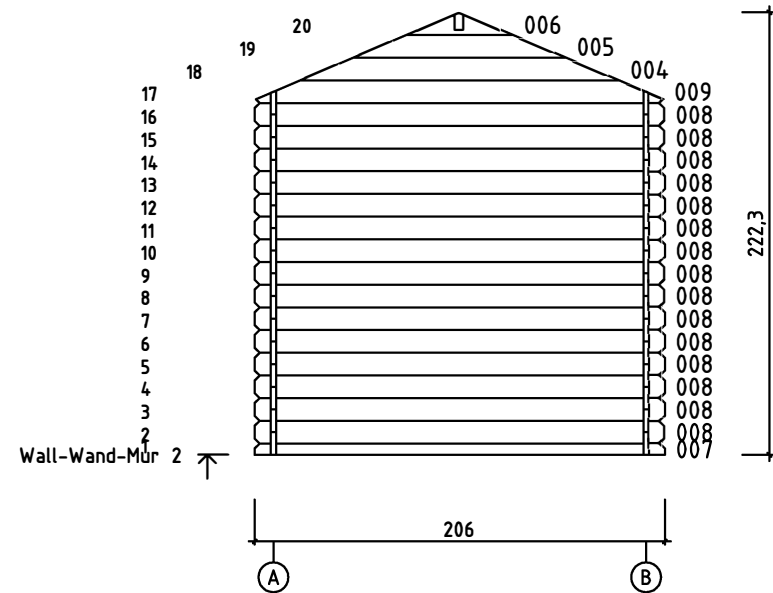
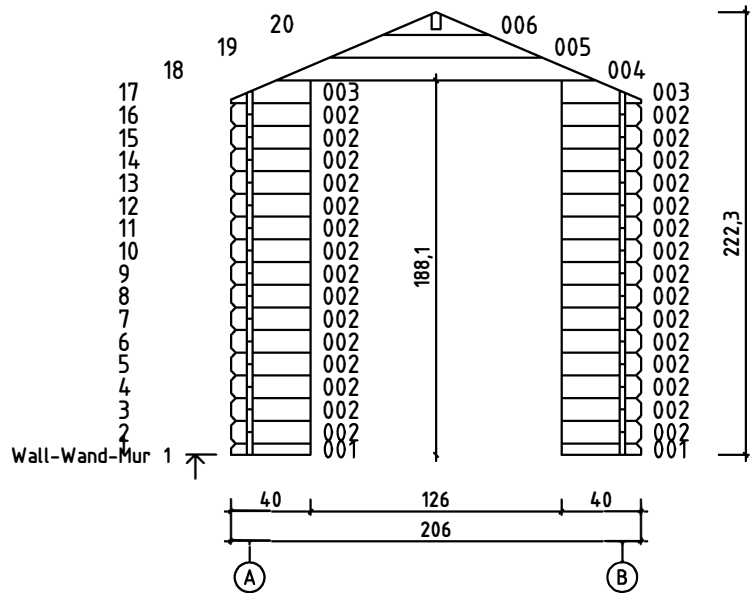

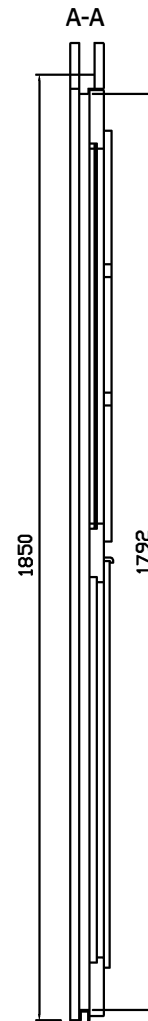
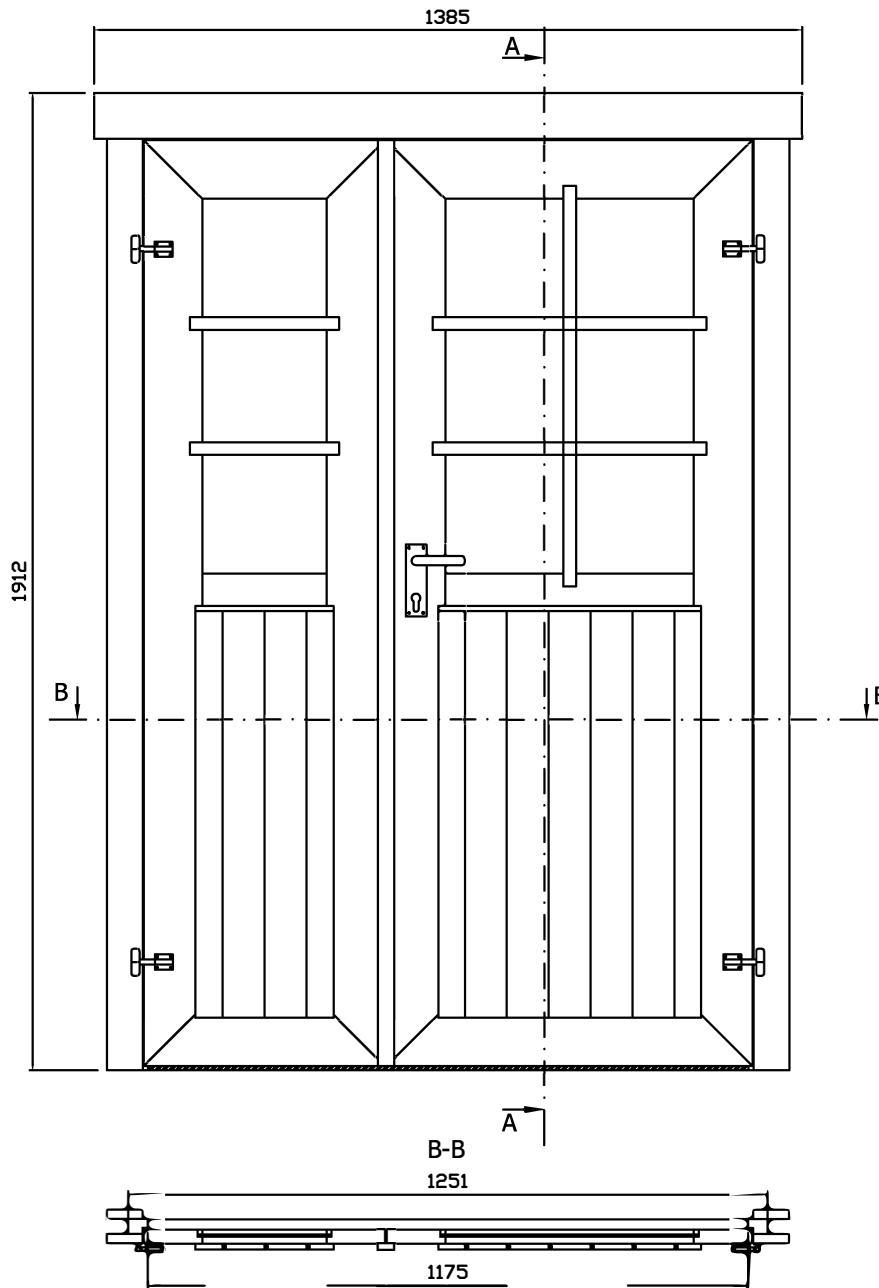





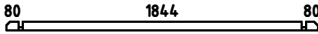
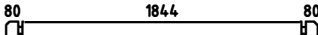
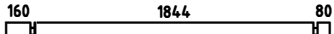
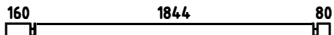
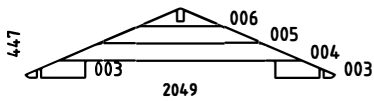
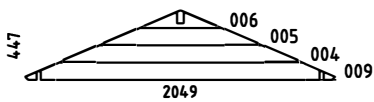
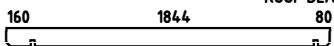

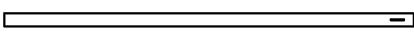

GROUNDPLAN - GRUNDPLAN - PLAN DE MASSE

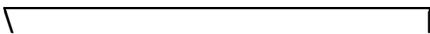

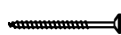







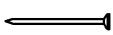

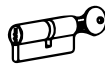
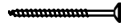
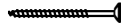
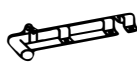

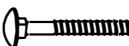

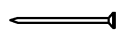
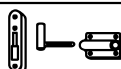

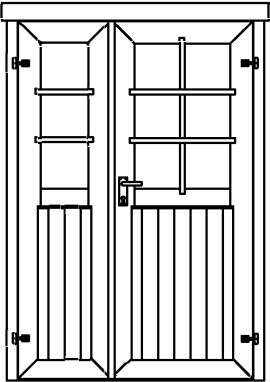
Door glass size - Glasgröße - Taille de la vitre:  
 1).259x750 mm  
 2).502x750 mm

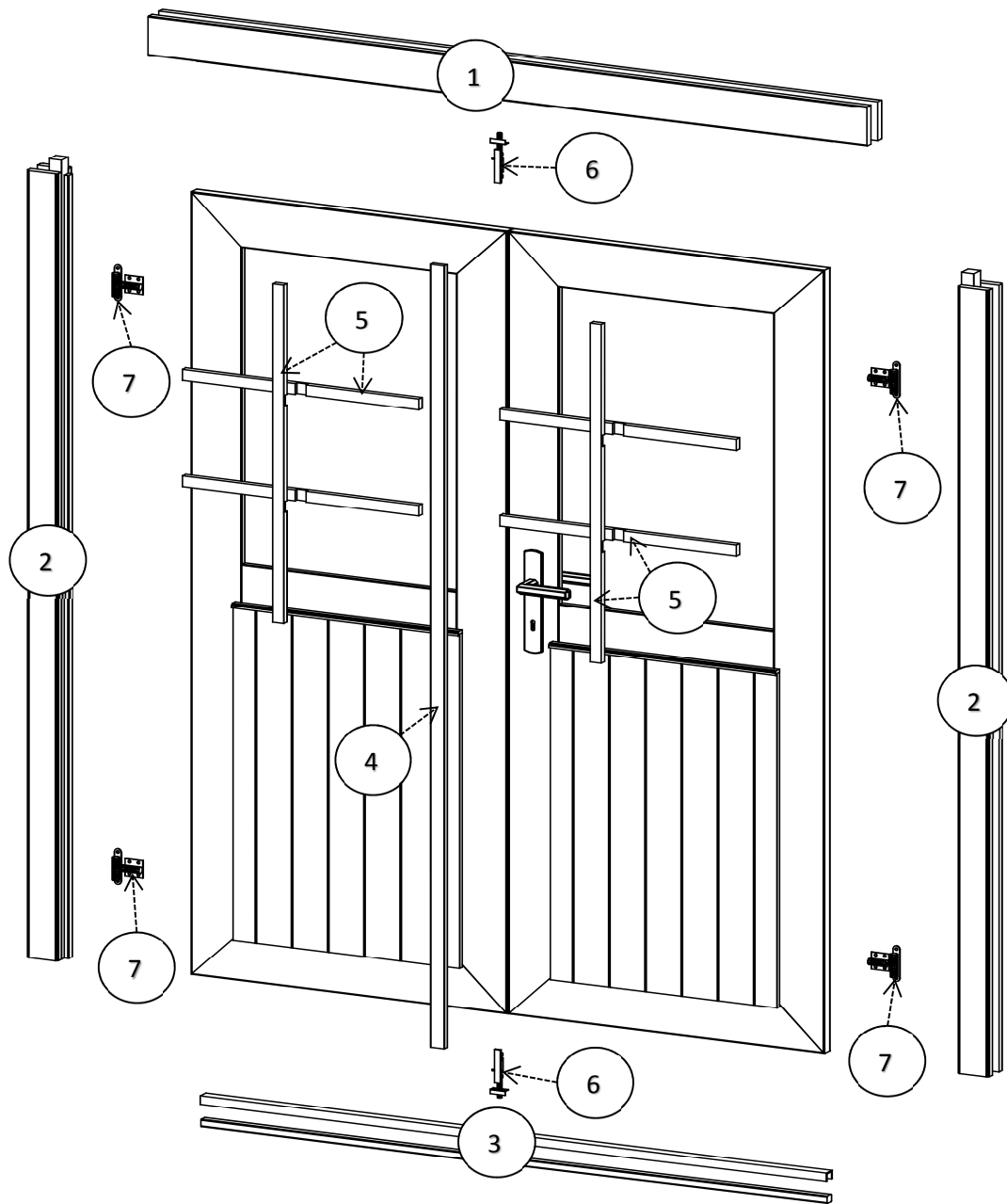
Pos	30.03.2015	Piecelist - Stücklist - Liste des composants	5/6	Q.	P. (mm)	L. (mm)
001				2	28x57	400
002				30	28x114	400
007				1	28x57	2060
008				45	28x114	2060
010				1	28x120	2140
011				1	28x120	2140
W1-1				1		
W2-1				1		
PR1		ROOF BEAM - DACHBALKEN - PANNE DE TOIT		1	44x120	2140
	ROOF BOARDS - DACHBRETTER - VOLIGES			48	90x15	1200
	ROOFING FELT FILLET - DACHPAPPENLEISTE - BAGUETTE DE FIXATION DU FEUTRE BITUMEUX			4	15x45	1250
	EAVES BOARD - TRAUFBRETT - BANDEAU DE TOIT			2	15x45	2140
KFS-1	STORM PROTECTION - STURMLEISTE - LATTE ANTI-TEMPETE			4	22x45	1760
DPP-1	ROOFING FELT - DACHPAPPE - FEUTRE BITUMEUX			3		2240
	GABLE MOULDING - GIEBELLEISTE - - PLANCHE DE RIVE			4	15x90	1250
HS12	SCREW FOR GABLE SEGMENT - SCHRAUBEN FÜR DECKBLATT - VIS POUR FIXATION LOSANGE DE FINITION			4	3.5x35	
HS22	SCREW FOR FIXING DOOR TO THE WALL - SCHRAUBE ZUR BEFESTIGUNG TÜR- ZARGE MIT WAND - VIS DE FIXATION DORMANT DE PORTE			2	3.5x50	
HS59	SCREW FOR DOORSTEP - SCHRAUBEN FÜR SWELLE - VIS DE FIXATION DU SEUIL DE PORTE			3	4.5x65	
HS3	SCREW FOR FILLET - SCHRAUBE ZUR BEFESTIGUNG TÜRLEISTE - - VIS D'ASSEMBLAGE DU CADRE DE PORTE			5	3x30	
HS56	SCREW FOR FIXING BOLT HINGE - SCHRAUBE FÜR TÜRRIGEL - - VIS DE FIXATION POUR CHARNIÈRES ET GONDS DE PORTE			16	4x30	
HS58	SCREW FOR FIXING BOLT HINGE - SCHRAUBE FÜR TÜRRIGEL - - VIS DE FIXATION POUR CHARNIÈRES ET GONDS DE PORTE			12	4x40	
	SCREW FOR GEORGIAN BARS - SCHRAUBE FÜR SPROSSEN - VIS DE BARRES GEORGIENNE			10	2.5x20	
HS41	SCREW FOR DOOR JAMB - SCHRAUBE FÜR TÜRRAHMEN - VIS DE FIXATION POUR MONTANT DE PORTE			2	5x90	

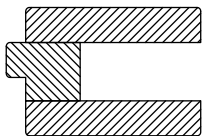
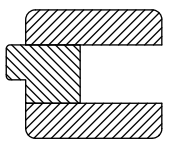
Pos	30.03.2015	Piecelist - Stücklist - Liste des composants	6/6	Q.	P. (mm)	L. (mm)
SH28	HAMMER BLOCK - SCHLAGHOLZ - CALLE DE FRAPPE 28mm			1		
NF	ROOFING NAILS FOR ROOFING FELT - NÄGEL FÜR DACHPAPPE - - POINTE DE FIXATION POUR FEUTRE BITUMEUX			64	2.8x15	
TL4	DOOR HANDLE FITTINGS - TÜRGRIF - GARNITURE DE POIGNÉE DE PORTE			1		
TL5	DOOR HANDLE FITTINGS - TÜRGRIF - SET DE GARNITURES DE SERRURE DE PORTE			1		
	CYLINDER - ZYLINDERSCHLOSS - CYLINDRE DE SERRURE			1	30/30	
HS16	SCREW FOR GABLE MOULDING - SCHRAUBEN FÜR GIEBELLEISTE - - VIS DE FIXATION POUR PLANCHE DE RIVE			16	3.5x50	
HS32	SCREW FOR EAVES BOARDS - SCHRAUBEN FÜR TRAUFBRETT - - VIS DE FIXATION POUR BANDEAU DE TOIT			10	4x40	
TL	LATCH BOLT FÜR DOUBLE DOOR - TORRIEGEL - LOQUET POUR DOUBLE PORTE			2		90
GS	GABLE SEGMENT - DECKBLATT - LOSANGE DE FINITION			2		
SFS	NUT FOR STORM PROTECTION - SCHRAUBENMUTTER FÜR STURMLEISTE - - ÉCROU POUR LAME ANTI-TEMPETE			8	D6	
BFS	BOLT FOR STORM PROTECTION - BOLZEN FÜR STURMLEISTE - - VIS POUR LAME ANTI-TEMPETE			8	6x60	
DFS	WASHER FOR STORM PROTECTION - DICHTSCHEIBE FÜR STURMLEISTE - - RONDELLE POUR LAME ANTI-TEMPETE			8	D6	
NFD	ZN NAIL FOR ROOFING FELT FILLET - ZN NÄGEL FÜR DACHPAPPENLEISTE - - POINTE POUR BAGUETTE FIXATION FEUTRE BITUMEUX			16	2x40	
NF2	ZN NAIL FOR ROOF - ZN NÄGEL FÜR DACHBRETT - POINTE POUR TOIT			104	2x50	
	MALE BOLT HINGE FOR DOOR - TÜRRIEGEL - PARTIE MALE DE CHARNIERE DE PORTE			4	DIN15-57	
HS41	SCREW FOR DOOR JAMB - SCHRAUBE FÜR TÜRRAHMEN - VIS DE FIXATION POUR MONTANT DE PORTE			2	4x60	
	DOOR - TÜR - PORTE 1251x1850 SGA		TUK.2.056.SVP.MMX28b	1		
						

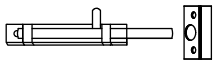
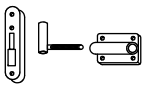

Pos	Piece list - Stückliste - Liste des pièces	Q.	P (mm)
1		1	66x100
2		2	66x80
3		1	19x20
4		1	13x32
5		6	15x25
6		2	
7		4	

