

*Kjell B*  
1/8

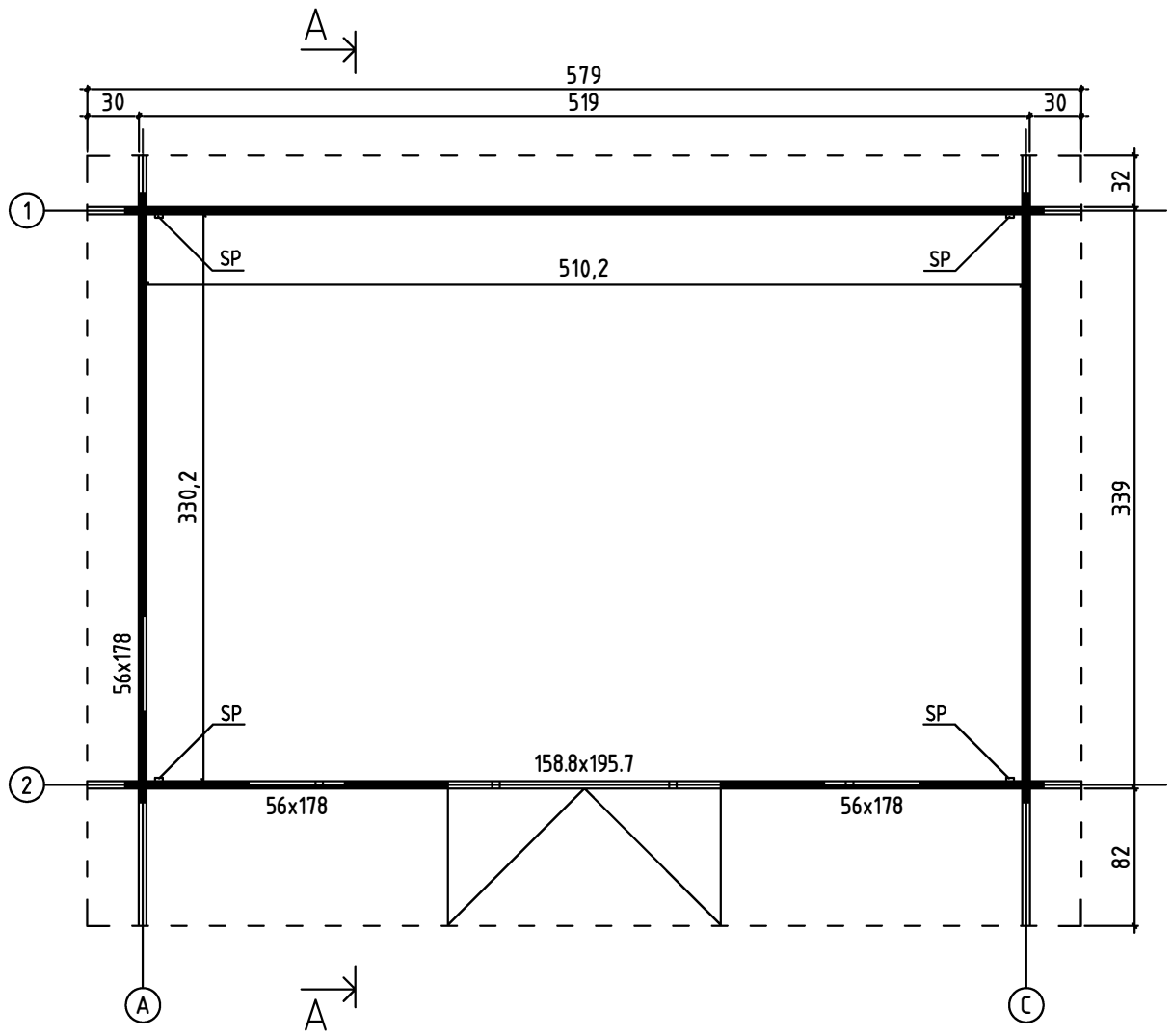

7.04.2016







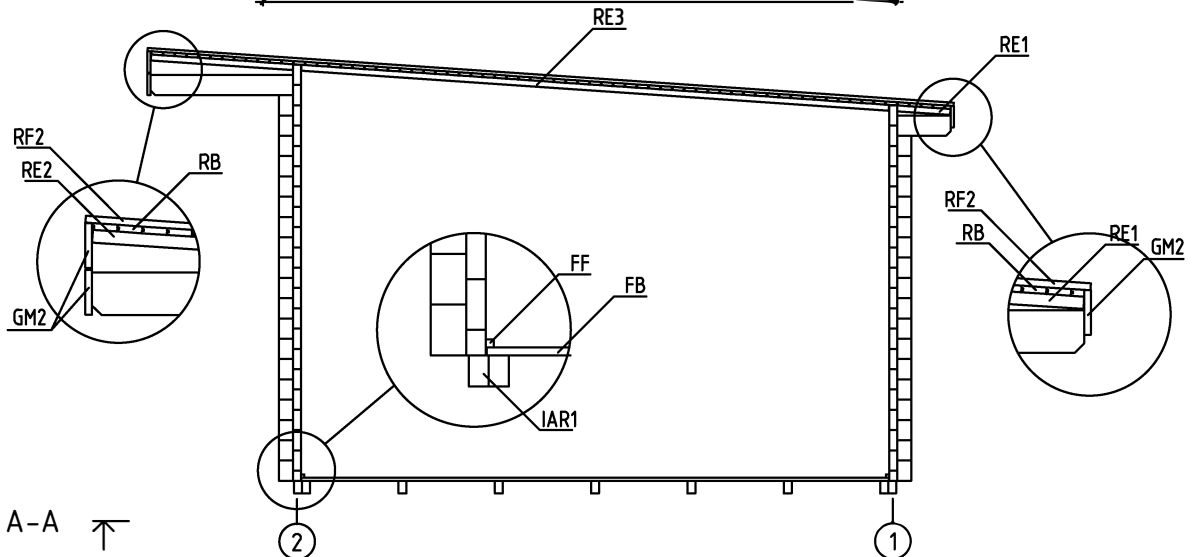
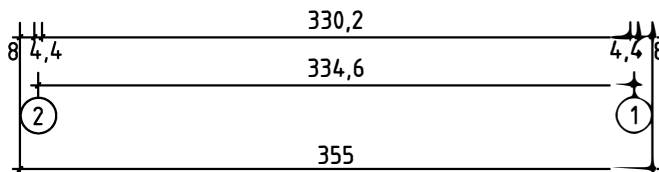
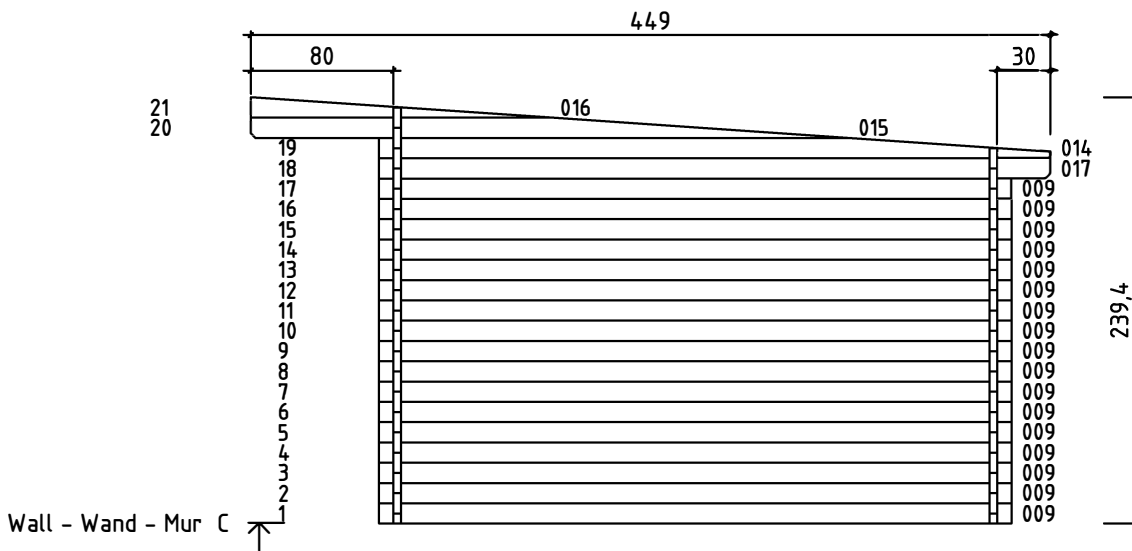
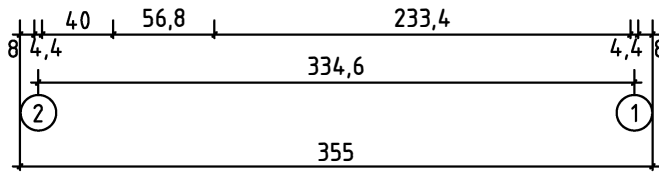
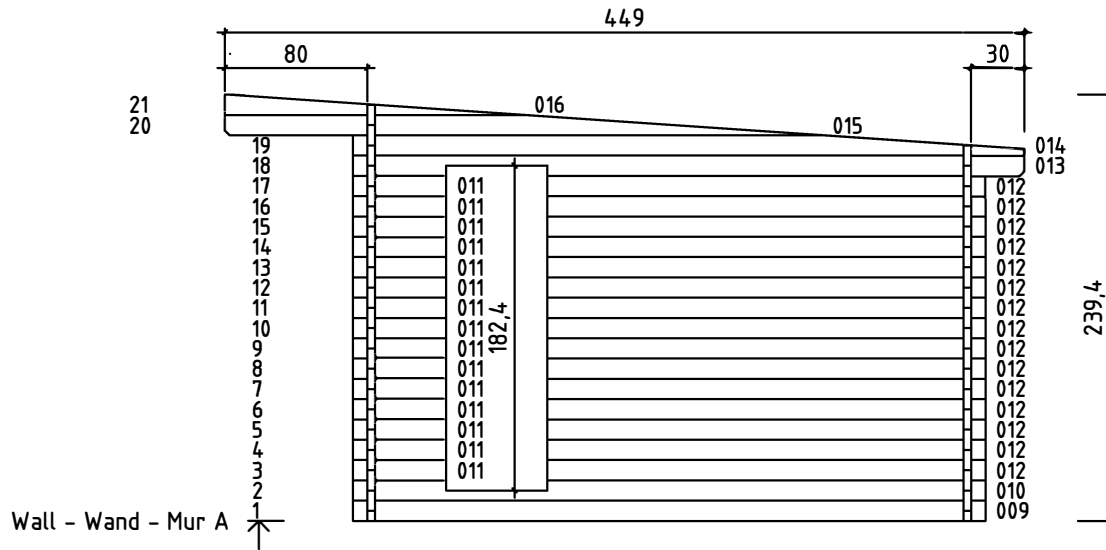

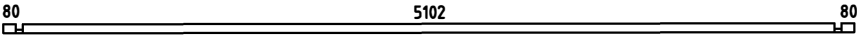
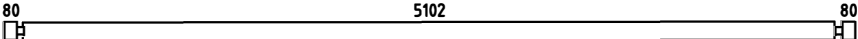
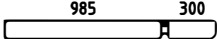
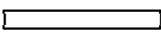
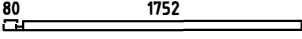
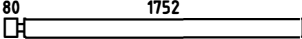
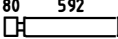

GROUNDPLAN - GRUNDPLAN - PLAN DE MASSE

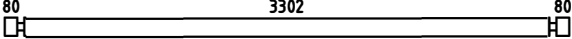
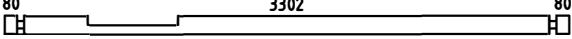

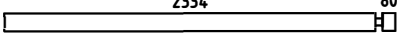
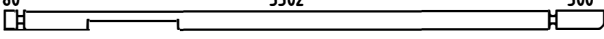
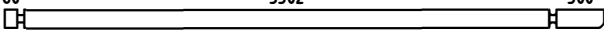
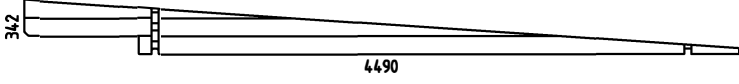
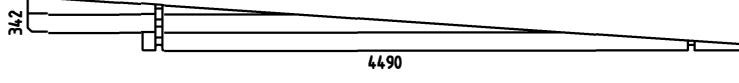
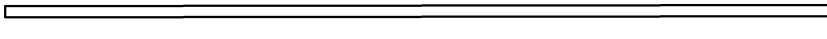

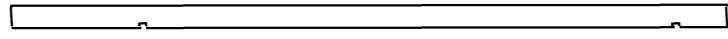





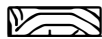
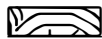



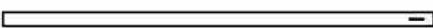

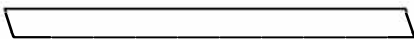

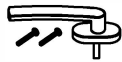
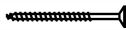

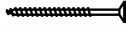
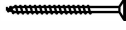
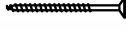







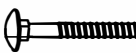

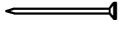

Pos	07.04.2016	6/8	Q.	P (mm)	L (mm)
001			1	44x57	5350
002			19	44x114	5350
003			4	44x114	1329
004			6	44x114	985
005			2	44x57	1876
006			2	44x114	1876
007			32	44x114	716
008			32	44x114	592
009			18	44x114	3550
010			1	44x114	3550
011			15	44x114	524
012			15	44x114	2458
013			1	44x114	3770
017			1	44x114	3770
WA-1			1		
WC-1			1		
IAR2	FOUNDATION - FUNDAMENT - FONDATION 		9	45x70	5090
IAR1	FOUNDATION - FUNDAMENT - FONDATION 		2	45x70	3380
SR1	RAFTER - DACHSPARREN - CHEVRON 		4	44x140	4509
FB	FLOOR BOARDS - FUSSBODENBRETTER - LAME DE PLANCHER 		57	90x18	3298
RB1	ROOF BOARDS - DACHBRETTER - VOLIGES 		51	90x18	4439
RB2	ROOF BOARDS - DACHBRETTER - VOLIGES 		51	90x18	1351
FF	FLOOR FILLET-FUSSBODENLEISTE - CORNIERE DE FINITION DU PLANCHER 			18x18	16.79

Pos	07.04.2016	7/8	Q.	P (mm)	L (mm)
RF1	ROOFING FELT FILLET - DACHPAPPENLEISTE - BAGUETTE DE FIXATION DU FEUTRE BITUMEUX		2	18x58	2855
RF2	ROOFING FELT FILLET - DACHPAPPENLEISTE - BAGUETTE DE FIXATION DU FEUTRE BITUMEUX		2	18x58	4536
RE1	ROOF EDGE REINFORCEMENT - DACHRANDVERSTÄRKUNG - CORNIERE DE RENFORT DE BORD DE TOIT		2	28x34	297
RE2	ROOF EDGE REINFORCEMENT - DACHRANDVERSTÄRKUNG - CORNIERE DE RENFORT DE BORD DE TOIT		2	28x34	800
RE3	ROOF EDGE REINFORCEMENT - DACHRANDVERSTÄRKUNG - CORNIERE DE RENFORT DE BORD DE TOIT		2	28x34	3306
SP	STORM PROTECTION - STURMLEISTE - LATTE ANTI-TEMPETE		2	22x45	2500
SP	STORM PROTECTION - STURMLEISTE - LATTE ANTI-TEMPETE		2	22x45	2050
GM1	GABLE MOULDING - GIEBELLEISTE - PLANCHE DE RIVE		2	18x120	4510
GM2	GABLE MOULDING - GIEBELLEISTE - PLANCHE DE RIVE		3	18x120	5826
	WINDOW HANDLE FITTINGS-FENSTERGRIFF - POIGNÉE D'OUVERTURE DE FENETRE		3		
	SCREW FOR GABLE MOULDING - SCHRAUBEN FÜR GIEBELLEISTE - VIS DE FIXATION POUR PLANCHE DE RIVE		66	3.5x50	
	SCREW FOR FILLET - SCHRAUBE ZUR BEFESTIGUNG TÜRLEISTE - VIS D'ASSEMBLAGE DU CADRE DE PORTE		5	3x30	
	SCREW FOR ROOF EDGE REINFORCEMENT - SCHRAUBEN FÜR DACHRANDVERSTÄRKUNG - VIS POUR RENFORT DE BORD DE TOIT		24	4x40	
	SCREW FOR ROOF BEAMS - SCHRAUBEN FÜR DACHBALKEN - VIS POUR PANNE DE TOIT		12	5x120	
	SCREW FOR GABLE - SCHRAUBEN FÜR GIEBEL - VIS POUR FIXATION DES PIGNONS		8	5x120	
	SCREW FOR 1. WALL BEAM - SCHRAUBE FÜR 1. BOHLENREIHE - VIS DE FIXATION DES FONDATIONS		8	5x90	
	SCREW FOR FUNDAMENT - SCHRAUBEN ZUR BEFISTIGUNG FUNDAMENT - VIS POUR FONDATION		26	5x90	
	SCREW FOR DOOR JAMB - SCHRAUBE FÜR TÜRRAHMEN - VIS DE FIXATION POUR MONTANT DE PORTE		4	5x90	
	SCREW FOR Pos. 004, 005 - SCHRAUBEN FÜR für Pos. 004, 005 VIS POUR FIXATION DERNIÈRE RANGÉE MADRIERS (MURS AVANT ET ARRIÈRE)		10	6x180	
	ZN NAIL FOR FLOOR FILLET - ZN NÄGEL FÜR FUSSBODENLEISTE - POINTE POUR CORNIERE DE FINITION DU PLANCHER		34	1.4x40	
	HAMMER BLOCK - SCHLAGHOLZ - CALLE DE FRAPPE		1		
	ZN NAIL FOR ROOFING FELT FILLET - ZN NÄGEL FÜR DACHPAPPENLEISTE - POINTE POUR BAGUETTE FIXATION FEUTRE BITUMEUX		34	2x40	
	NUT FOR STORM PROTECTION - SCHRAUBENMUTTER FÜR STURMLEISTE - ÉCROU POUR LAME ANTI-TEMPETE		8		
	BOLT FOR STORM PROTECTION - BOLZEN FÜR STURMLEISTE - VIS POUR LAME ANTI-TEMPETE		8		
	WASHER FOR STORM PROTECTION - DICHTSCHEIBE FÜR STURMLEISTE - RONDELLE POUR LAME ANTI-TEMPETE		8		

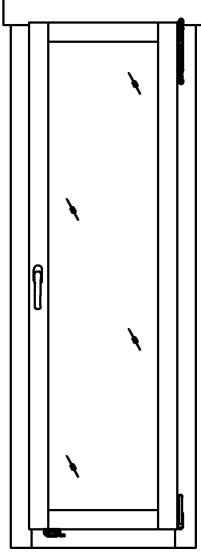
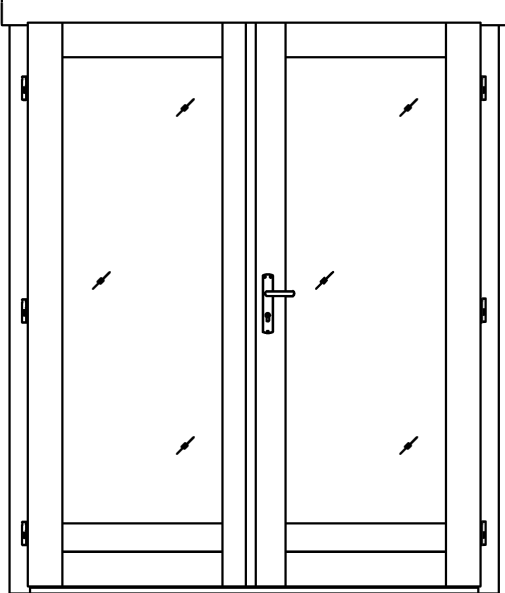
Pos	07.04.2016	8/8	Q.	P (mm)	L (mm)
	ZN NAIL FOR ROOF - ZN NÄGEL FÜR DACHBRETTTER - POINTE POUR TOIT		374	2x50	
	ZN NAIL FOR FLOOR - ZN NÄGEL FÜR FUSSBODENBRETTTER - CLOUS POUR PLANCHER		406	2x50	
	SET OF DOOR LOCK COVERS - SCHLOSSBLENDEN - SET DE GARNITURES DE SERRURE DE PORTE		1		
	MALE BOLT HINGE FOR DOOR - TÜRRIEGEL - PARTIE MALE DE CHARNIERE DE PORTE		6		
	DOOR HANDLE FITTINGS-TÜRGRIF - SET DE GARNITURES DE SERRURE DE PORTE		1		
	CYLINDER -ZYLINDERSCHLOSS - CYLINDRE DE SERRURE		1	30x35	
	WINDOW-FENSTER-FENETRE 560x1780      AK.1.100.PSP      DGP+		3		
	DOOR-TÜR-PORTE 1588x1957      TUK.1.100.PVP.MM      DGP+		1		