

5840

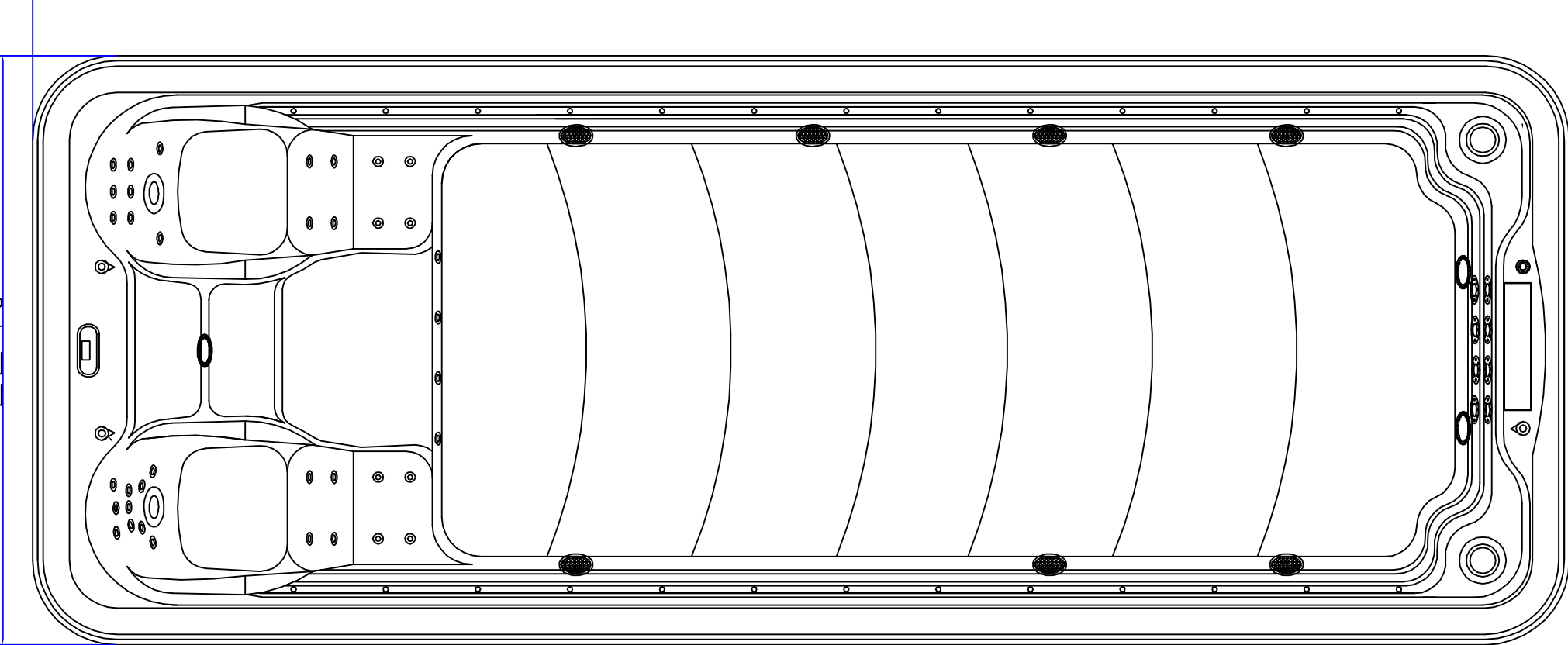

2240

1250

