

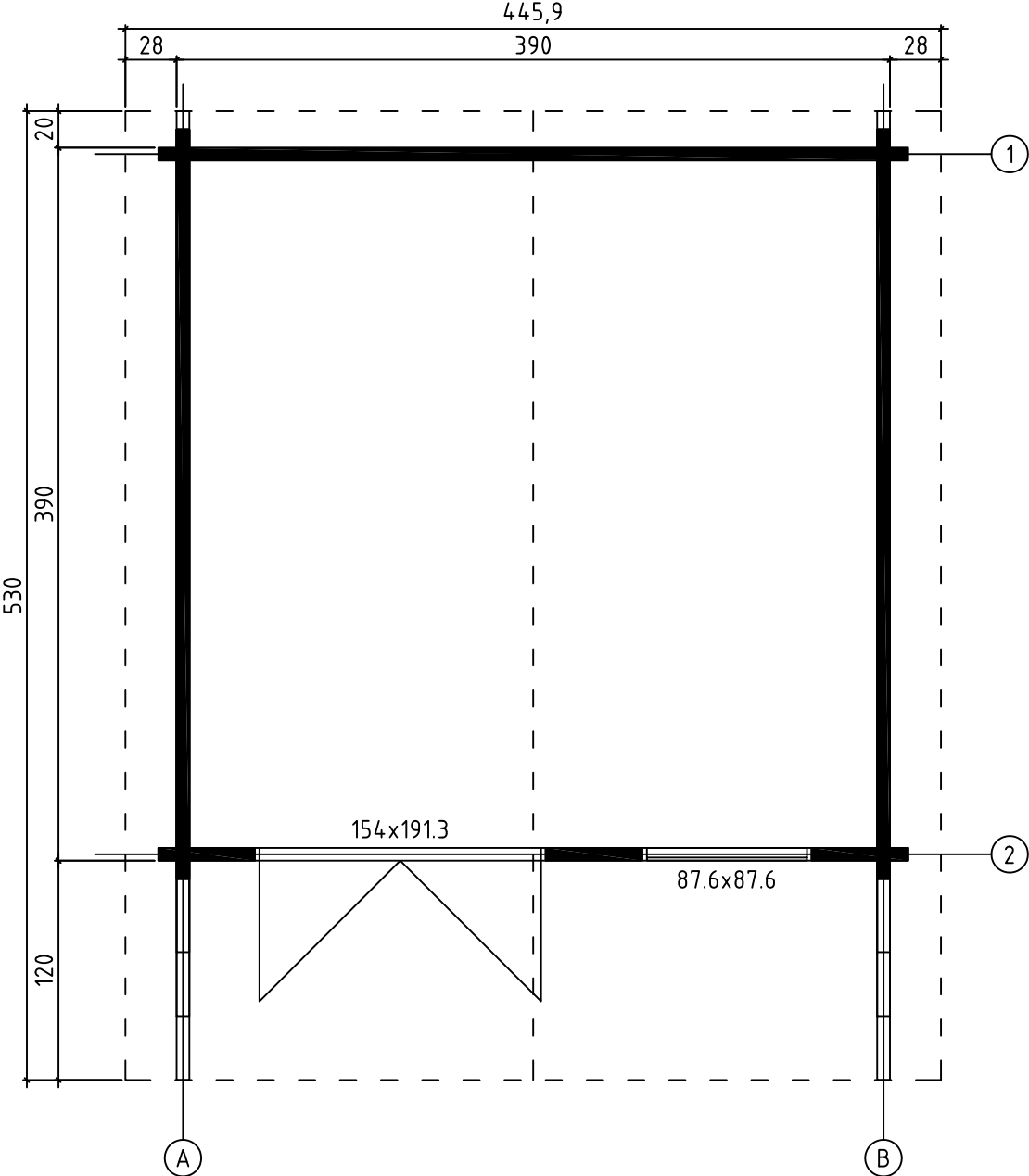

GROUNDPLAN - GRUNDPLAN - PLAN DE MASSE

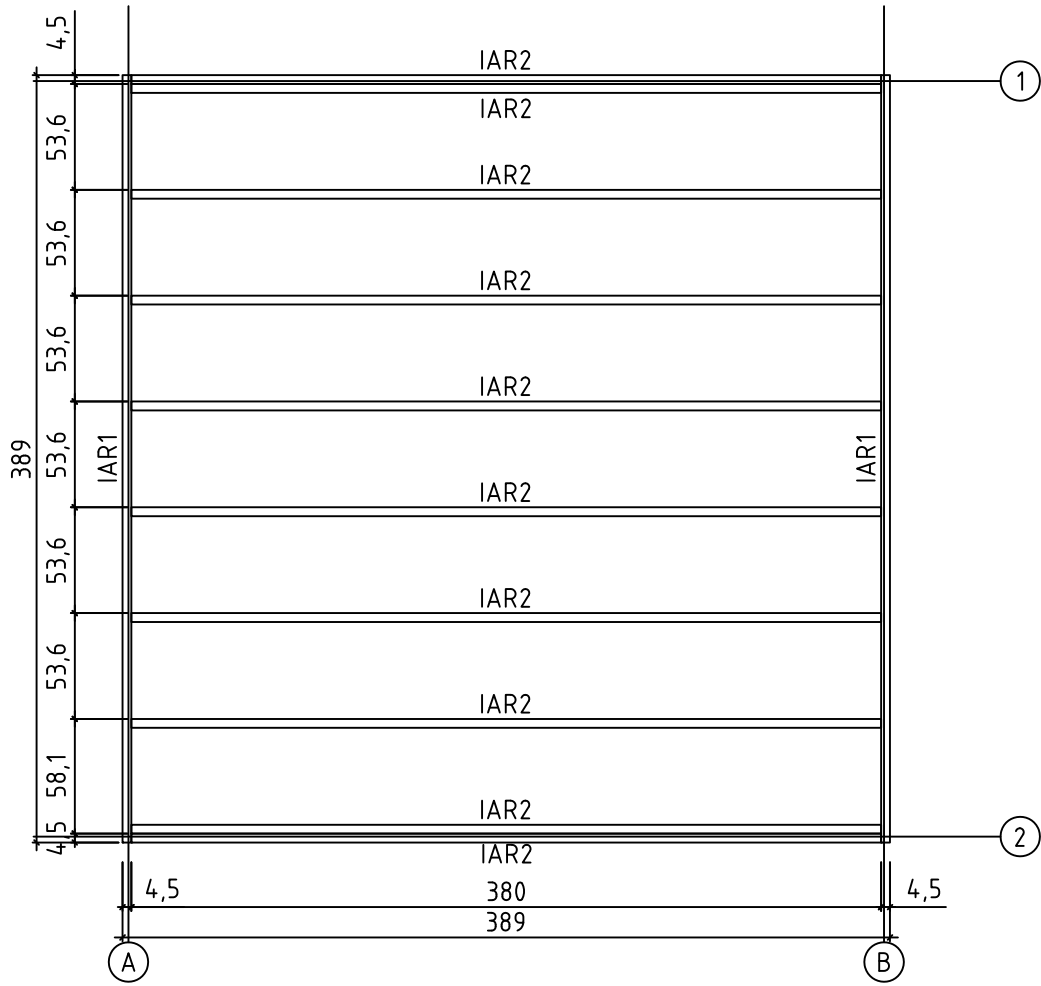

FOUNDATION - FUNDAMENT - FONDAATION





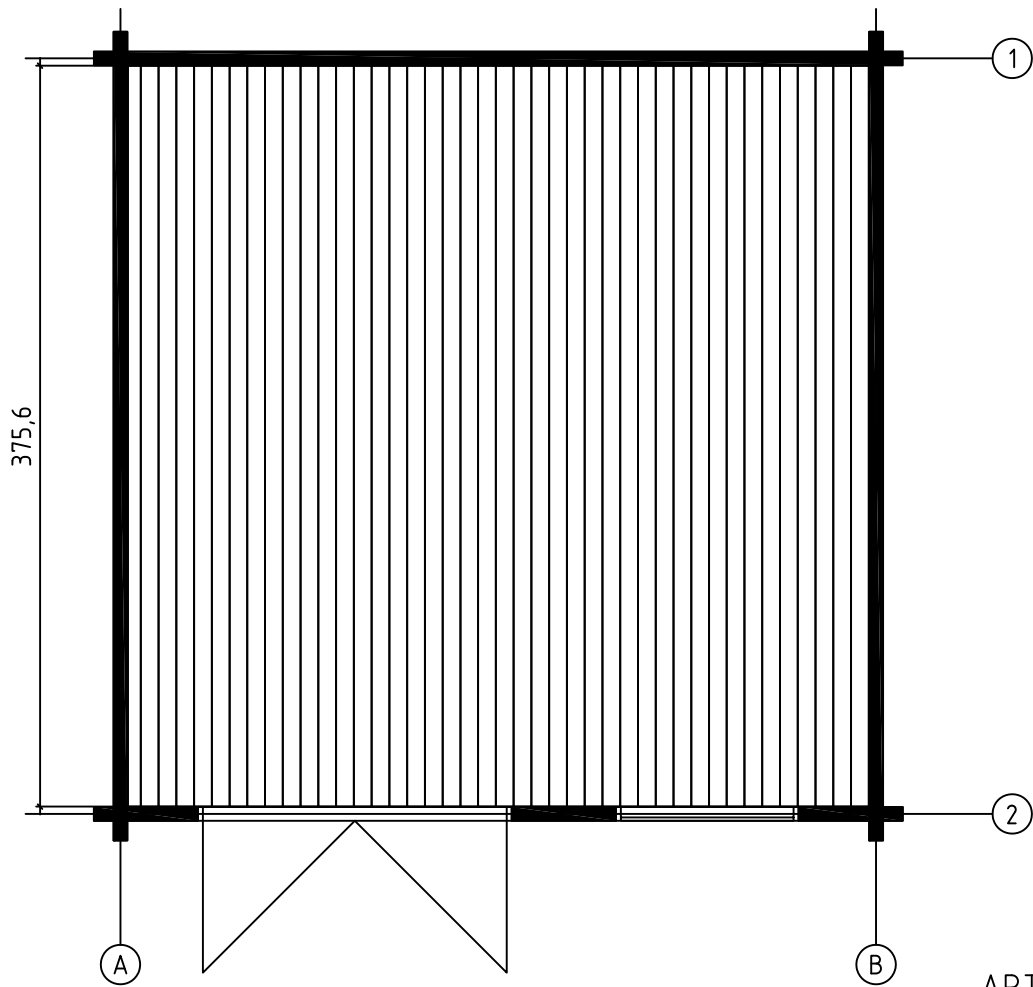



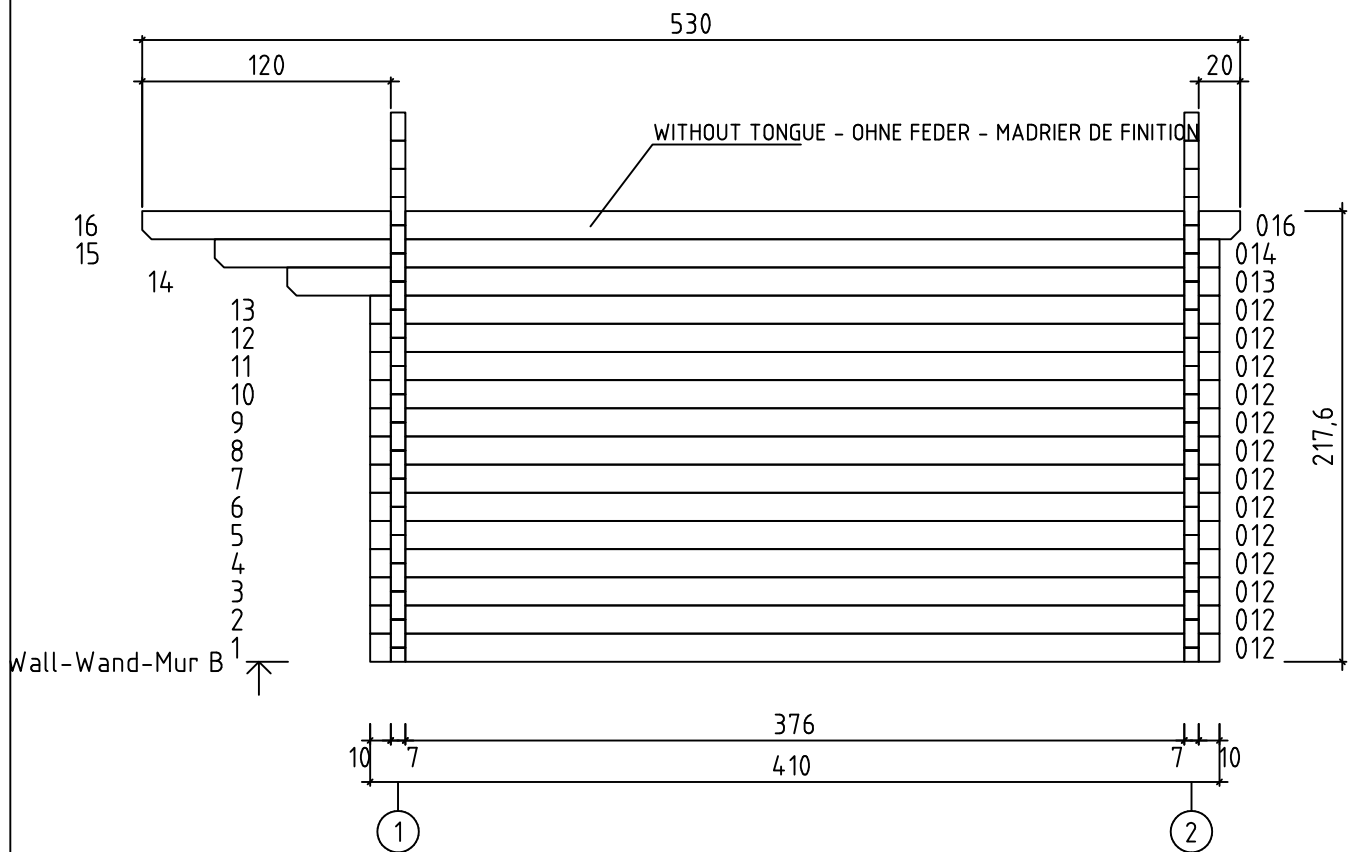
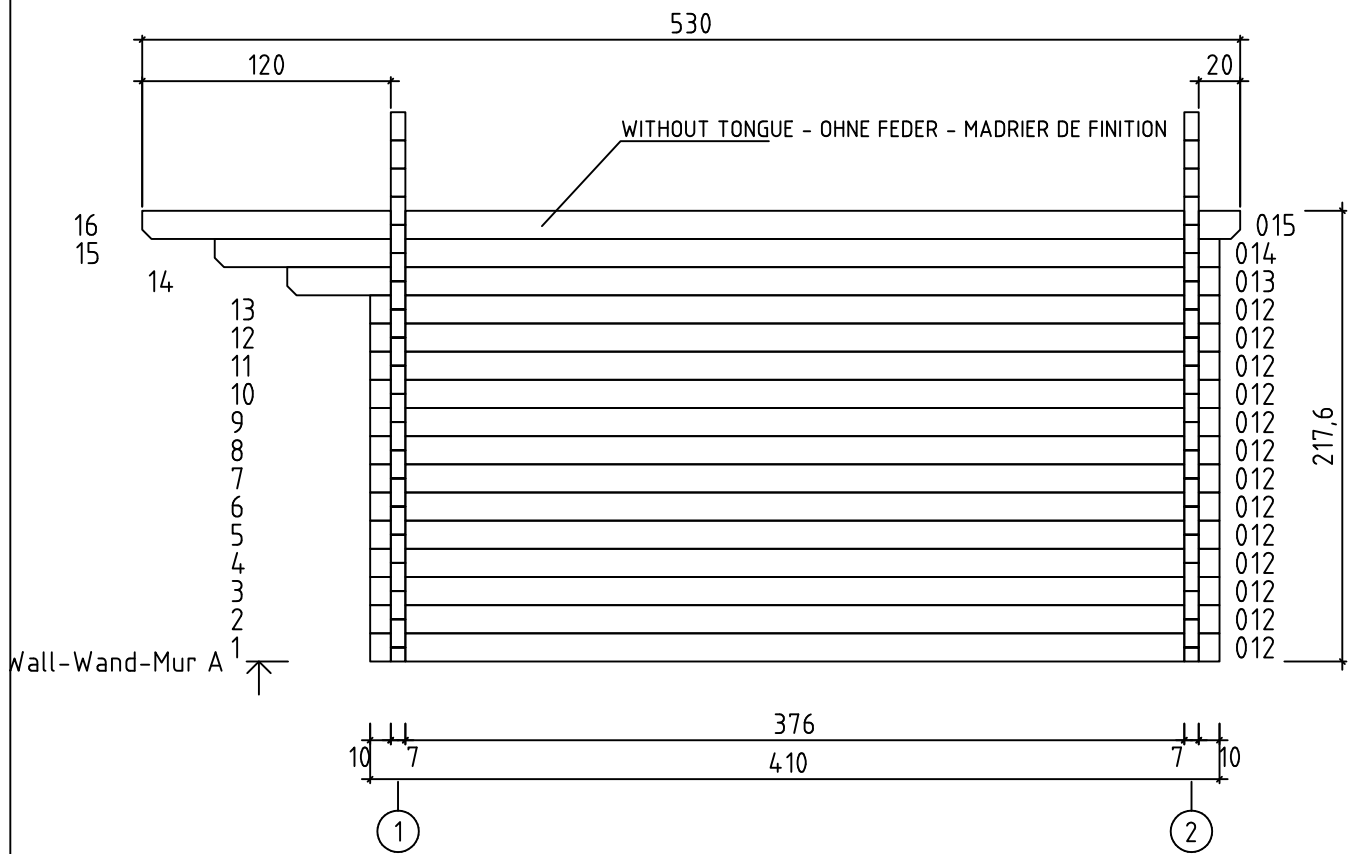

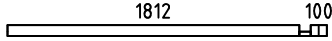

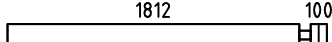

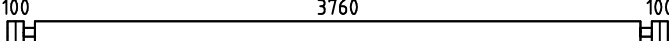
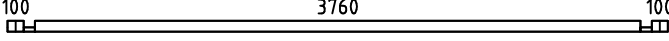
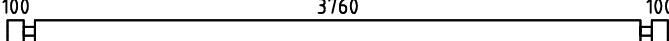
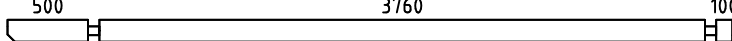
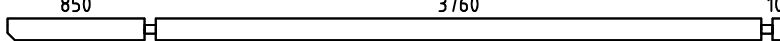
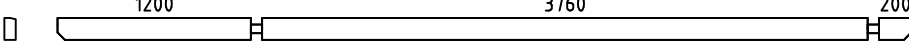
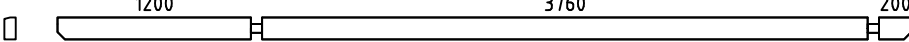
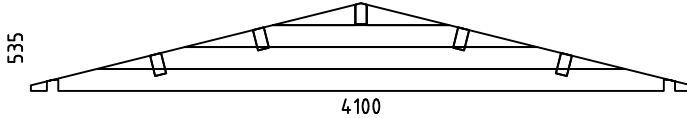
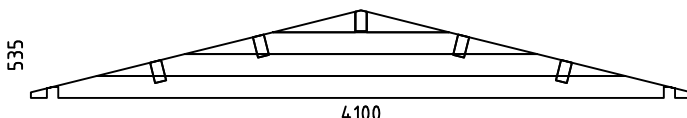
FLOOR BOARDS - FUSSBODENBRETTER - PLAN POSE PLANCHER

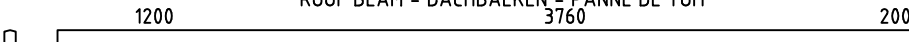
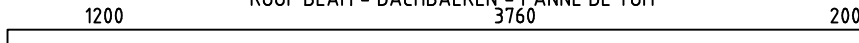







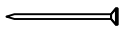

Pos	9.07.2013	ART.NO. 700102 Piece list - Stückliste - Liste des pieces	6/8	Q.	P (mm)	L (mm)
001				1	70x68	528
002				1	70x68	1982
003				21	70x136	528
004				7	70x136	1982
005				7	70x136	528
006				16	70x136	4100
011				1	70x68	4100
012				26	70x136	4100
013				2	70x136	4500
014				2	70x136	4850
015				1	70x136	5300
016				1	70x136	5300
W1-1				1		
W2-1				1		
IAR1	FOUNDATION - FUNDAMENT - FONDATION 			2	45x70	3890
IAR2	FOUNDATION - FUNDAMENT - FONDATION 			10	45x70	3800
PR11	ROOF BEAM - DACHBALKEN - PANNE DE TOIT 			1	70x140	5300
PR21	ROOF BEAM - DACHBALKEN - PANNE DE TOIT 			4	70x140	5300
	FLOOR BOARDS - FUSSBODENBRETTER - LAME DE PLANCHER 			42	90x18	3756
	ROOF BOARDS - DACHBRETTER - VOLIGES 			118	90x18	2300
FL	FLOOR FILLET-FUSSBODENLEISTE - CORNIERE DE FINITION DU PLANCHER 				18x18	15.02
DPL	ROOFING FELT FILLET - DACHPAPPENLEISTE - BAGUETTE DE FIXATION DU FEUTRE BITUMEUX 			4	18x58	2350
M12	TREADED ROD M12 - GEWINDESTANGE M12 - TIGE FILETÉE M12 			4		185

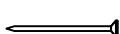
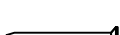
Pos	9.07.2013	ART.NO. 700102 Piece list - Stückliste - Liste des pieces	7/8	Q.	P (mm)	L (mm)
M12	TREADED ROD M12 - GEWINDESTANGE M12 - TIGE FILETÉE M12			4		2000
LPL	FIXING FILLET - FIXIRUNGSLEISTE - PROFIL DE FIXATION			2	20x70	876
LPL	FIXING FILLET - FIXIRUNGSLEISTE - PROFIL DE FIXATION			2	20x70	916
LPL	FIXING FILLET - FIXIRUNGSLEISTE - PROFIL DE FIXATION			1	20x70	1540
LPL	FIXING FILLET - FIXIRUNGSLEISTE - PROFIL DE FIXATION			2	20x70	1913
TB	EAVES BOARD - TRAUFBRETT - BANDEAU DE TOIT			4	18x90	2650
DRV	ROOF EDGE REINFORCEMENT - DACHRANDVERSTÄRKUNG - CORNIERE DE RENFORT DE BORD DE TOIT			4	28x34	2650
GL	GABLE MOULDING - GIEBELLEISTE PLANCHE DE RIVE			4	18x120	2350
FS	WINDOW HANDLE FITTINGS-FENSTERGRIFF - POIGNÉE D'OUVERTURE DE FENETRE			1		
TS	BOLT FOR WINDOW HANDLE FITTINGS - BOLZEN FÜR FENSTERGRIFF BESCHLAG - BOULON POUR POIGNÉE D'OUVERTURE DE FENETRE			2		
KL4	LENGTHENING BOLT FOR TREADED ROD -VERLÄNGERUNGSMUTTER FÜR GEWINDESTANGE - MANCHON DE RACCORDEMENT DE TIGE FILETÉE			4		
KL1	DRIVE NUT TREADED ROD - EINSHLAGMUTTER FÜR GEWINDESTANGE - ÉCROU A FRAPPER POUR TIGE FILETÉE			4		
KL2	NUT FOR TREADED ROD - MUTTER FÜR GEWINDESTANGE - ÉCROU POUR TIGE FILETÉE			4		
KL3	PLAIN WASHER TREADED ROD - UNTERLEGSCHIEBE FÜR GEWINDESTANGE - RONDELLE PLATE POUR TIGE FILETÉE			4		
	SCREW FOR GABLE SEGMENT - SCHRAUBEN FÜR DECKBLATT VIS POUR FIXATION LOSANGE DE FINITION			4	3.5x35	
HS83	SCREW FOR FIXING FILLET - SCHRAUBEN FÜR FIXIRUNGSLEISTE VIS POUR PROFIL DE FIXATION			31	3.5x50	
HS16	SCREW FOR GABLE MOULDING - SCHRAUBEN FÜR GIEBELLEISTE VIS DE FIXATION POUR PLANCHE DE RIVE			32	3.5x50	
HS32	SCREW FOR EAVES BOARDS - SCHRAUBEN FÜR TRAUFBRETT - VIS DE FIXATION POUR BANDEAU DE TOIT			24	4x40	
HS26	SCREW FOR ROOF EDGE REINFORCEMENT - SCHRAUBEN FÜR DACHRANDVERSTÄRKUNG - VIS POUR RENFORT DE BORD DE TOIT			24	4x40	
HS40	SCREW FOR 1. WALL BEAM - SCHRAUBE FÜR 1. BOHLENREIHE VIS DE FIXATION DES FONDATIONS			7	5x120	
HS43	SCREW FOR ROOF BEAMS - SCHRAUBEN FÜR DACHBALKEN - VIS POUR PANNE DE TOIT			14	5x120	
	SCREW FOR GABLE - SCHRAUBEN FÜR GIEBEL - VIS POUR FIXATION DES PIGNONS			16	5x120	
HS39	SCREW FOR FUNDAMENT - SCHRAUBEN ZUR BEFESTIGUNG FUNDAMENT - VIS POUR FONDATION			24	5x90	
SH70	HAMMER BLOCK - SCHLAGHOLZ - CALLE DE FRAPPE			1		
	SCREW FOR DOORSTEP - SCHRAUBEN FÜR TÜRSCHWELLE - VIS DE FIXATION DU SEUIL DE PORTE			3	4.5x65	

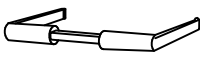
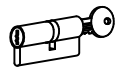
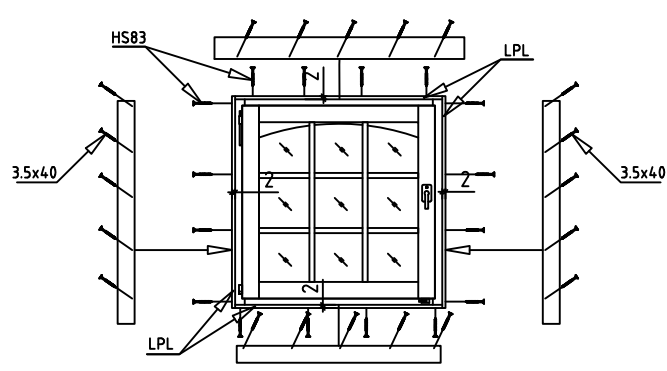
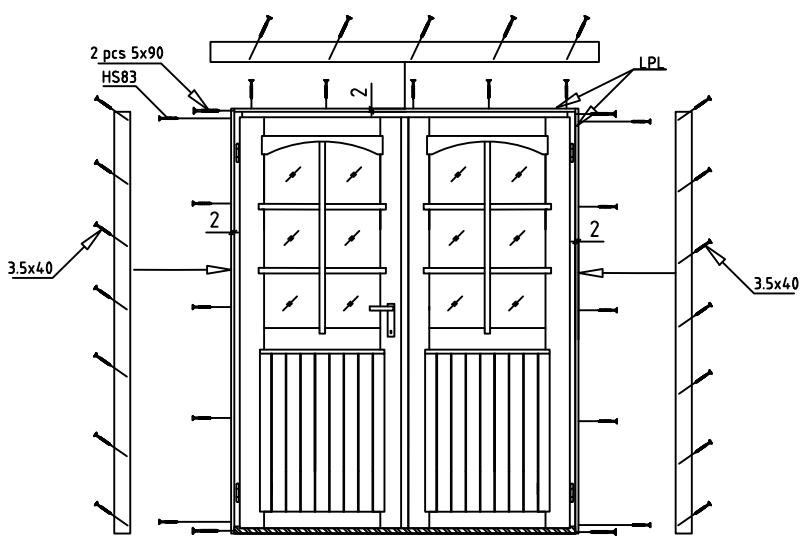
Pos	9.07.2013	ART.NO. 700102 Piece list - Stückliste - Liste des pieces	8/8	Q.	P (mm)	L (mm)
NFD	ZN NAIL FOR ROOFING FELT FILLET - ZN NÄGEL FÜR DACHPAPPEN-LEISTE - POINTE POUR BAGUETTE FIXATION FEUTRE BITUMEUX			24	2x40	
NFF	ZN NAIL FOR FILLETS - ZN NÄGEL FÜR LEISTEN - POINTE POUR CORNIERE			30	1.4x40	
NF2	ZN NAIL FOR ROOF - ZN NÄGEL FÜR DACHBRETTER - POINTE POUR TOIT			492	2x40	
NH1	ZN NAIL FOR FLOOR - ZN NÄGEL FÜR FUSSBODENBRETTER - CLOUS POUR PLANCHER			344	2x40	
GS	GABLE SEGMENT-DECKBLATT - LOSANGE DE FINITION			2		
TS4	SET OF DOOR LOCK COVERS - SCHLOSSBLENDEN - SET DE GARNITURES DE SERRURE DE PORTE			1		
TS3	DOOR HANDLE FITTINGS-TÜRGRIF - SET DE GARNITURES DE SERRURE DE PORTE			1		
TS6	CYLINDER LOCK -ZYLINDERSCHLOSS - CYLINDRE DE SERRURE			1		
Week end A.9V.K	WINDOW-FENSTER-FENETRE 916x916			1		
Weeke nd TU .26V.K	DOOR-TÜR-PORTE 1580x1933			1		