

10.12.2020

Groundplan - Grundplan - Plan de masse -
 Planimetria - Plattegrond - Põhiplaan

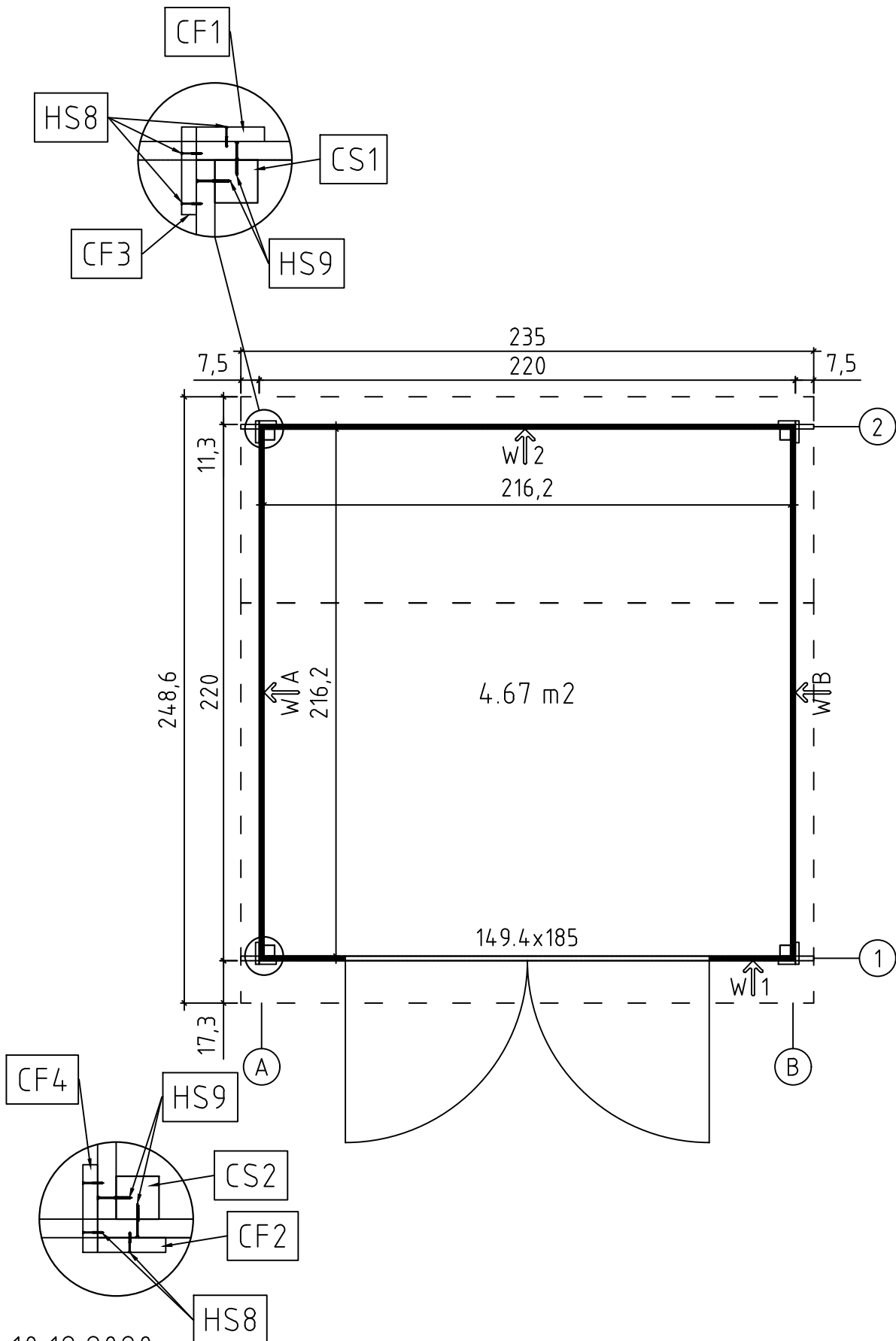

Foundation - Fundament - Fondation - Fondamenta - Fundering -
Immutatud alusraam

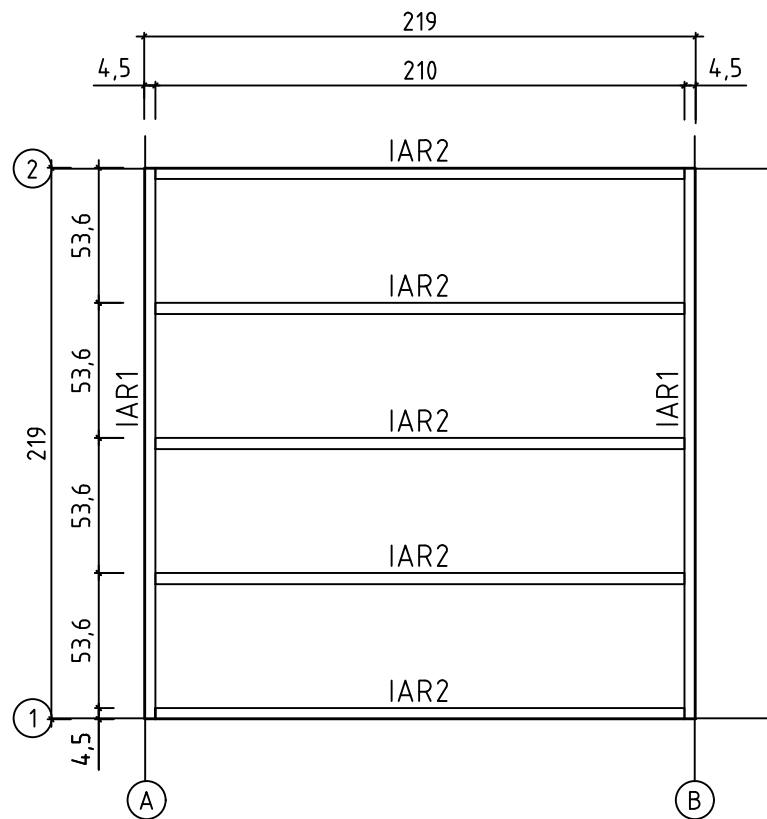



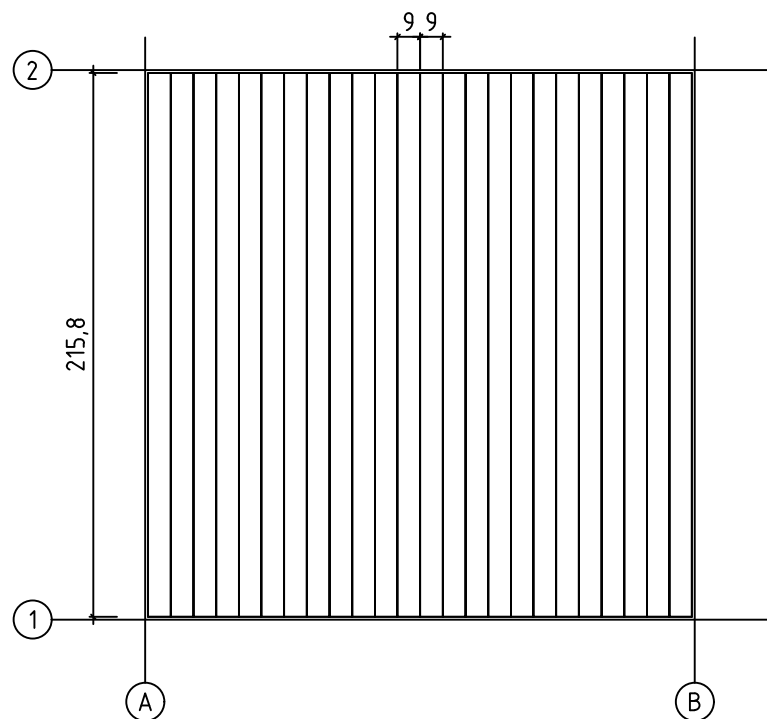

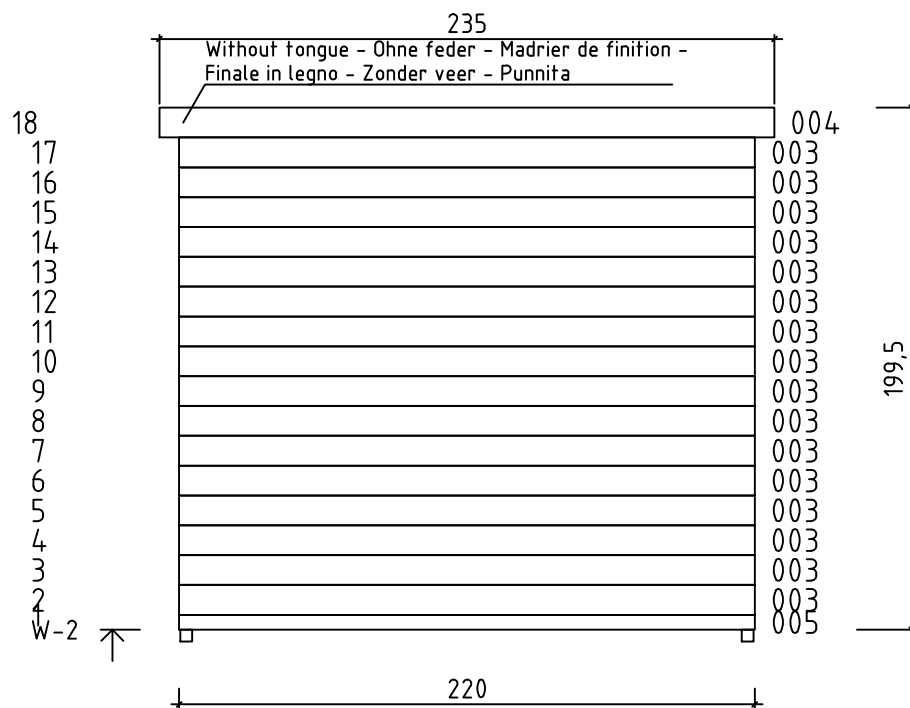
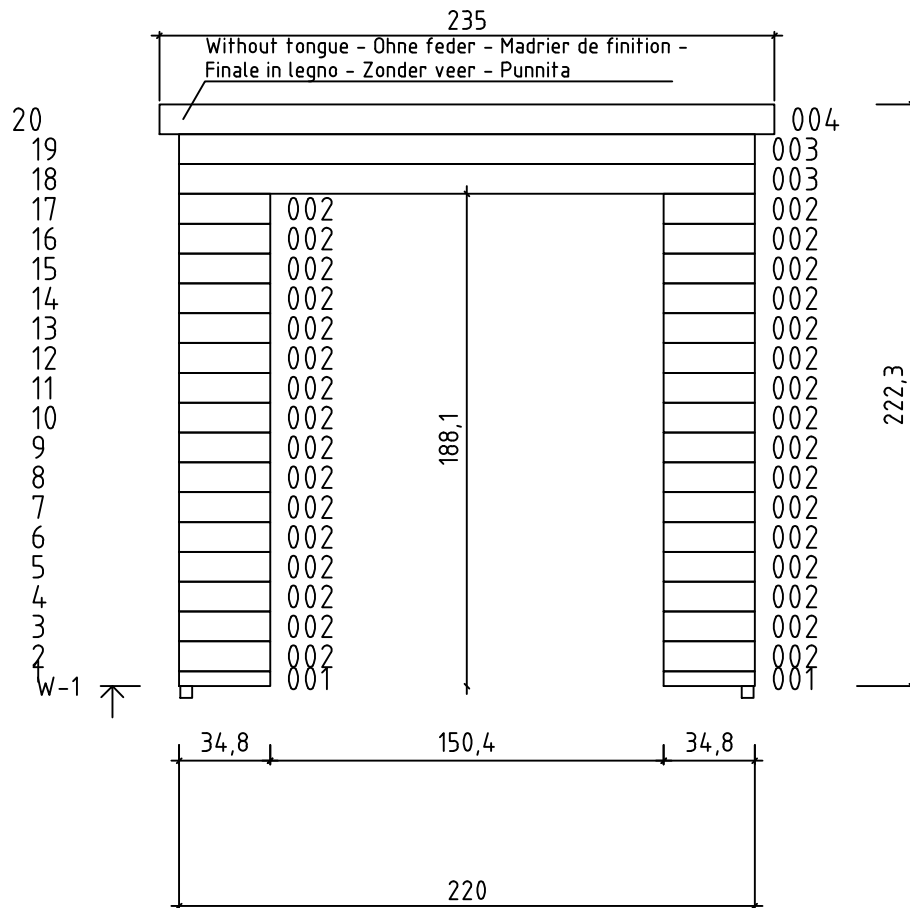

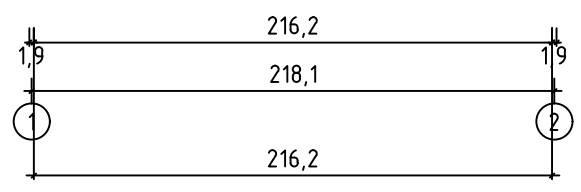
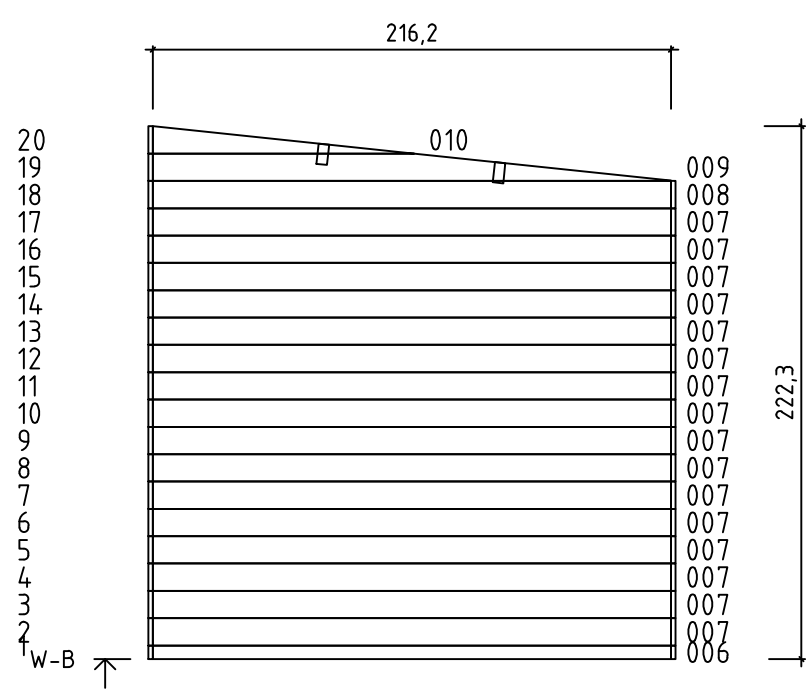
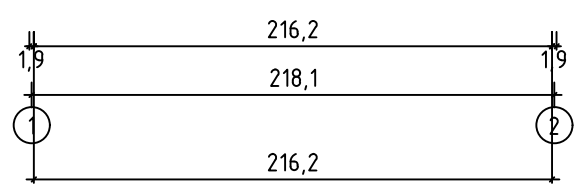
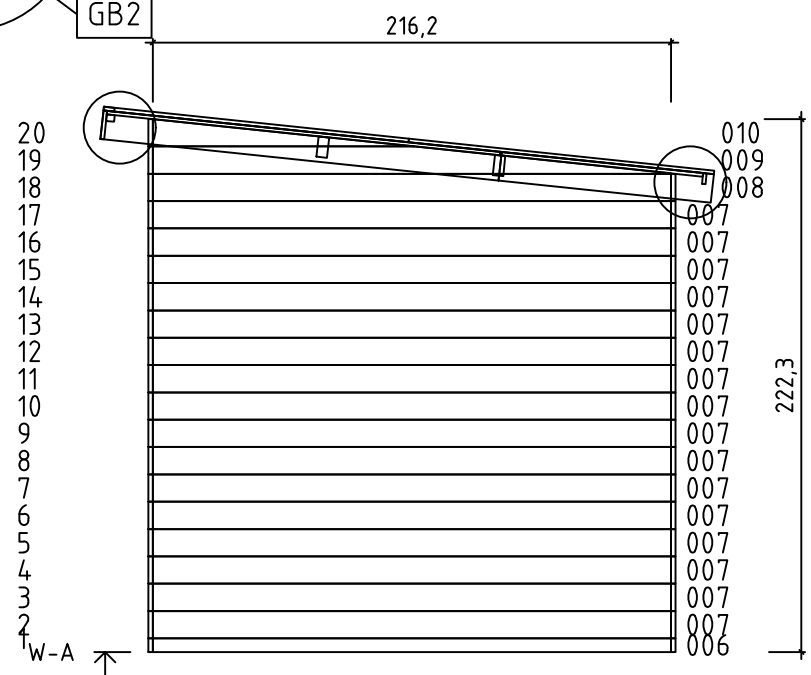
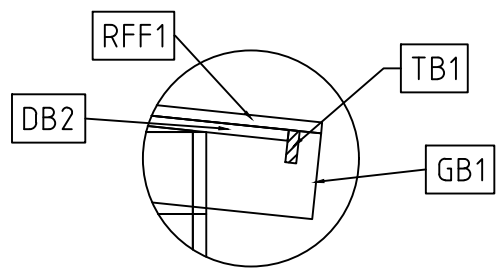
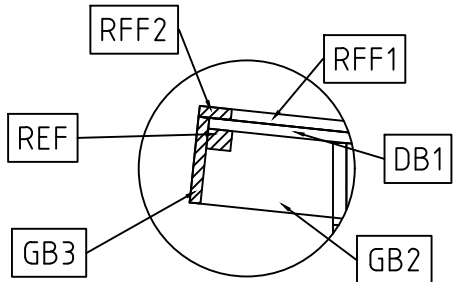







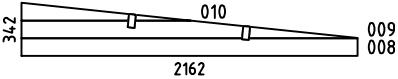
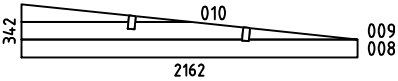

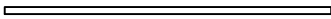
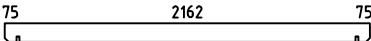
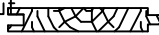
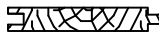
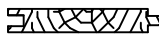











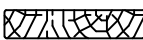
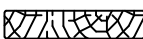
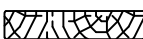
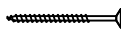
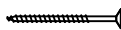

Floor boards - Fussbodenbretter - Plan pose plancher - Pavimento -
Vloerhout - Põrandalaudis

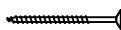
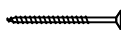
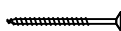
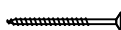





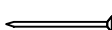

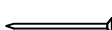

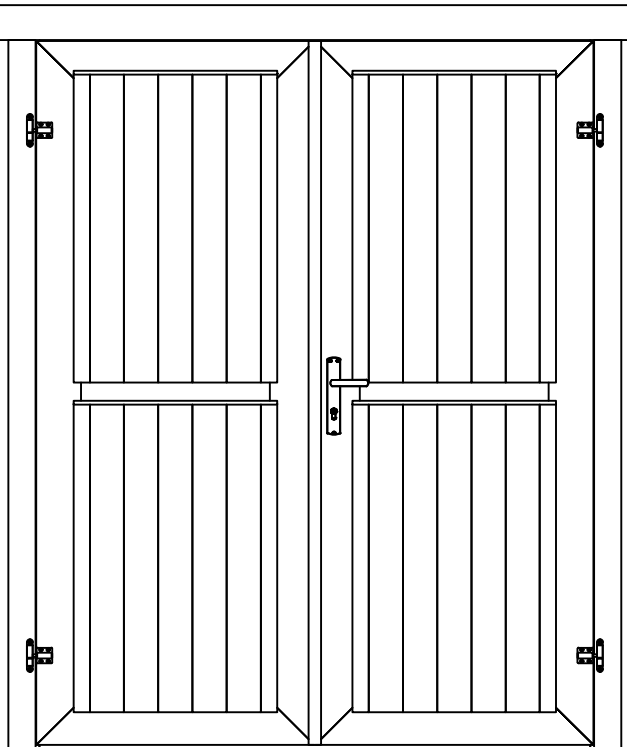
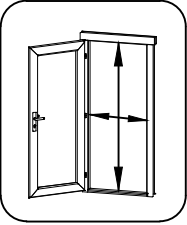

Pos	10.12.2020 Piece list - Stückliste - Liste des pièces - Elementi - Stuklijst - Tükítabel Art. Nr. 200100 6/7	Q	P (mm)	L (mm)
001		2	19x57	348
002		32	19x114	348
003		18	19x114	2200
004		2	19x114	2350
005		1	19x57	2200
006		2	19x57	2162
007		32	19x114	2162
WA-1		1		
WB-1		1		
IAR1	Foundation - Fundament - Fondation - Fondamenta - Fundering - Immutatud alusraam 	2	45x45	2190
IAR2	Foundation - Fundament - Fondation - Fondamenta - Fundering - Immutatud alusraam 	5	45x45	2100
A-PR1	Roof beam - Dachbalken - Panne de toit - Perlina del tetto - Gordingen / dakbalk - Pärilin 	2	44x120	2350
	Floor boards - Fussbodenbretter - Lame de plancher - Pavimento - Vloerhout - Põrandalaud 	24	90x15	2158
DB1	Roof boards - Dachbretter - Voliges - Perlina per tetto - Dakhout - Katuselaud 	27	90x15	1650
DB2	Roof boards - Dachbretter - Voliges - Perlina per tetto - Dakhout - Katuselaud 	27	90x15	850
	Floor fillet - Fussbodenteiste - Corniere de finition du plancher - Finitura per pavimento (battisco pa) - Vloerafwerkljst - Põrandaliist 		18x18	9
RFF1	Roofing felt fillet - Dachpappenleiste - Baguette de fixation du feutre bitumeux - Asse per fissaggio guaina bituminosa - Afdekljst asfaltpapier - Katusepapiilist 	4	15x45	1280
RFF2	Roofing felt fillet - Dachpappenleiste - Baguette de fixation du feutre bitumeux - Asse per fissaggio guaina bituminosa - Afdekljst asfaltpapier - Katusepapiilist 	1	15x45	2290
CF1	Corner fillet - Deckleiste - Profils de finition angles a l'exterieur - Massello d'angolo - (hoek)lijst - Nurgaliist 	2	15x70	1995
CF2	Corner fillet - Deckleiste - Profils de finition angles a l'exterieur - Massello d'angolo - (hoek)lijst - Nurgaliist 	2	15x70	2223
CF3	Corner fillet - Deckleiste - Profils de finition angles a l'exterieur - Massello d'angolo - (hoek)lijst - Nurgaliist 	2	15x90	1881
CF4	Corner fillet - Deckleiste - Profils de finition angles a l'exterieur - Massello d'angolo - (hoek)lijst - Nurgaliist 	2	15x90	2109
CS1	Corner stud - Eckpfosten - Poteaux d'angle pour fixation des madriers - Perno angolare - Hoek staander (kolom) - Nurgapost 	2	44x44	1970

Pos	10.12.2020 Piece list - Stückliste - Liste des pièces - Elementi - Stuklijst - Tükítabel Art. Nr. 200100 7/7	Q	P (mm)	L (mm)
CS2	Corner stud - Eckpfosten - Poteaux d'angle pour fixation des madriers - Perno angolare - Hoek staander (kolom) - Nurgapost 	2	44x44	2178
TB1	Fascia board - Traufbrett - Bandeau de toit - Finitura lati tetto - Gevellijst - Räästalaud 	1	15x45	2350
REF	Roof edge reinforcement - Dachrandverstärkung - Corniere de renfort de bord de toit - Rinforzo x tetto - Dakrand versterking - Räästatugevdus 	1	28x34	2350
GB1	Gable moulding - Giebelleiste - Planche de rive - Finitura per frontale e retro del tetto - Gevellijst - Viilulaud 	2	15x120	890
GB2	Gable moulding - Giebelleiste - Planche de rive - Finitura per frontale e retro del tetto - Gevellijst - Viilulaud 	2	15x120	1670
GB3	Gable moulding - Giebelleiste - Planche de rive - Finitura per frontale e retro del tetto - Gevellijst - Viilulaud 	1	15x120	2350
HS8	Screw for corner fillet - Schraube zur befestigung deckleiste - Vis pour profils de finition angles a l'exterieur - Viti per massellino d'angolo - Schroef voor afdekljst (hoek) - Kruvi nurgaliistudele 	60	3.5x35	
HS9	Screw for wall details - Schraube für wand details - Vis pour mur details - Viti per elementi della porta - Schroef voor wand details - Kruvi seinadetailidele 	296	3.5x50	
HS4	Screw for fascia boards - Schrauben für traufbretter - Vis pour fixation bandeau de toit - Viti x striscia del tetto - Schroef voor gevellijst - Kruvi räästalauale 	6	3x30	
HS12	Screw for metal corner - Holzschraube für metallwinkel - Vis de fixation des cornieres en métal - Viti per fissare suadretta di metallo di giunzione - Schroef voor metalen hoek - Kruvi nurgikule 	24	4x40	
HS12	Screw for roof edge reinforcement - Schrauben für dachrandverstärkung - Vis pour fixation corniere renfort de bord de toit - Viti x rinforzo bordo tetto - Schroef voor dakrand versterking - Kruvi räästatugevdusele 	6	4x40	
HS12	Screw for covering moulding - Schrauben für deckungsprofil - Vis de fixation profils horizontaux haut inférieur et extérieur d'encadrement de porte - Vite per cornice di copertura - Schroef voor afdekprofiel - Kruvi piirdelauale 	26	4x40	
HS18	Screw for roof beams - Schrauben für dachbalken - Vis pour fixation pannes de toit - Viti per perline del tetto - Schroef voor gordingen / dakbalken - Kruvi pärlinitele 	4	5x120	
HS18	Screw for gable - Schrauben für giebel - Vis pour fixation des pignons - Viti per timpano - Schroef voor gevelpunt - Kruvi viilude kinnitamiseks 	4	5x120	
HS16	Screw for foundation - Schrauben zur befestigung fundament - Vis de fixations des poutrelles de fondations - Viti x fondamenta - Schroef voor fundering - Kruvi alusraamile 	10	5x90	
NF2	Zn nail for floor fillet - Zn nägel für fussbodenleiste - Pointe pour corniere de finition du plancher - Chiodi x fissaggio pavimento - Spijker(nagel) voor vloer afdekljst - Nael põrandaliistule 	18	1.4x40	
SH19	Hammer block - Schlagholz - Calle de frappe - Blocco di legno da usare come cuscinetto quando si usa il martello - Slagklos - Löögiklots 	1		
NF4	Zn nail for roof - Zn nägel für dachbretter - Pointe pour fixation voliges de toit - Chiodi x perline tetto - Spijker(nagel) voor dakhout - Nael katuselauale 	150	2x50	
NF4	Zn nail for floor - Zn nägel für fussbodenbretter - Clous pour plancher - Chiodi x perline pavimento - Spijker(nagel) voor vloer - Nael põrandalauale 	125	2x50	
MW	Metal corner - Metallwinkel - Corniere en métal - Angolo di metallo - Metalen hoek - Nurgik 	4	40x40x40	
NF5	Zn nail for roofing felt fillet - Zn nägel für dachpappenleiste - Pointe pour baguette de fixation feutre bitumeux - Chiodi x carta bituminosa x tetto - Spijker(nagel) voor asfaltpapier afdekljst - Papiliistunael 	18	2x40	
	Door - Tür - Porte - Deur - Uks 1494x1850 TUL.2.050.IVP.MXT19 TA+28	1		

Pos	11.06.2019 Piece list - Stückliste - Liste des pièces - Elementi - Stuklijst - Tükítabel 1494x1850 TUL.2.050.IVP.MXT19 TA+28	1/2	Q	P (mm)	L (mm)
  <p data-bbox="1364 398 1497 425">1418x1794 mm</p>					
1	Upper door jamb - Türrahmen oben - Cadre de porte supérieur - Telaio superiore della porta - Bovendorpel - Ukse ülemine leng		1	57x100	1628
2	Left door jamb - Türrahmen links - Cadre de porte gauche - Telaio montante sinistro della porta - Linkerstijl deurframe - Ukse vasak leng		1	57x80	1850
3	Right door jamb - Türrahmen rechts - Cadre de porte droit - Telaio montante destro della porta - Rechterstijl deurframe - Ukse parem leng		1	57x80	1850
4	Doorstep - Swelle - Barre de seuil - Soglia della porta - Deurdorpel - Lävepak		1	18x18	1418
5	Connection strip - Deckleiste - Baguette de battement - Profilo verticale della porta - Stulplijst - kokkuvältsiliist		1	13x32	1812

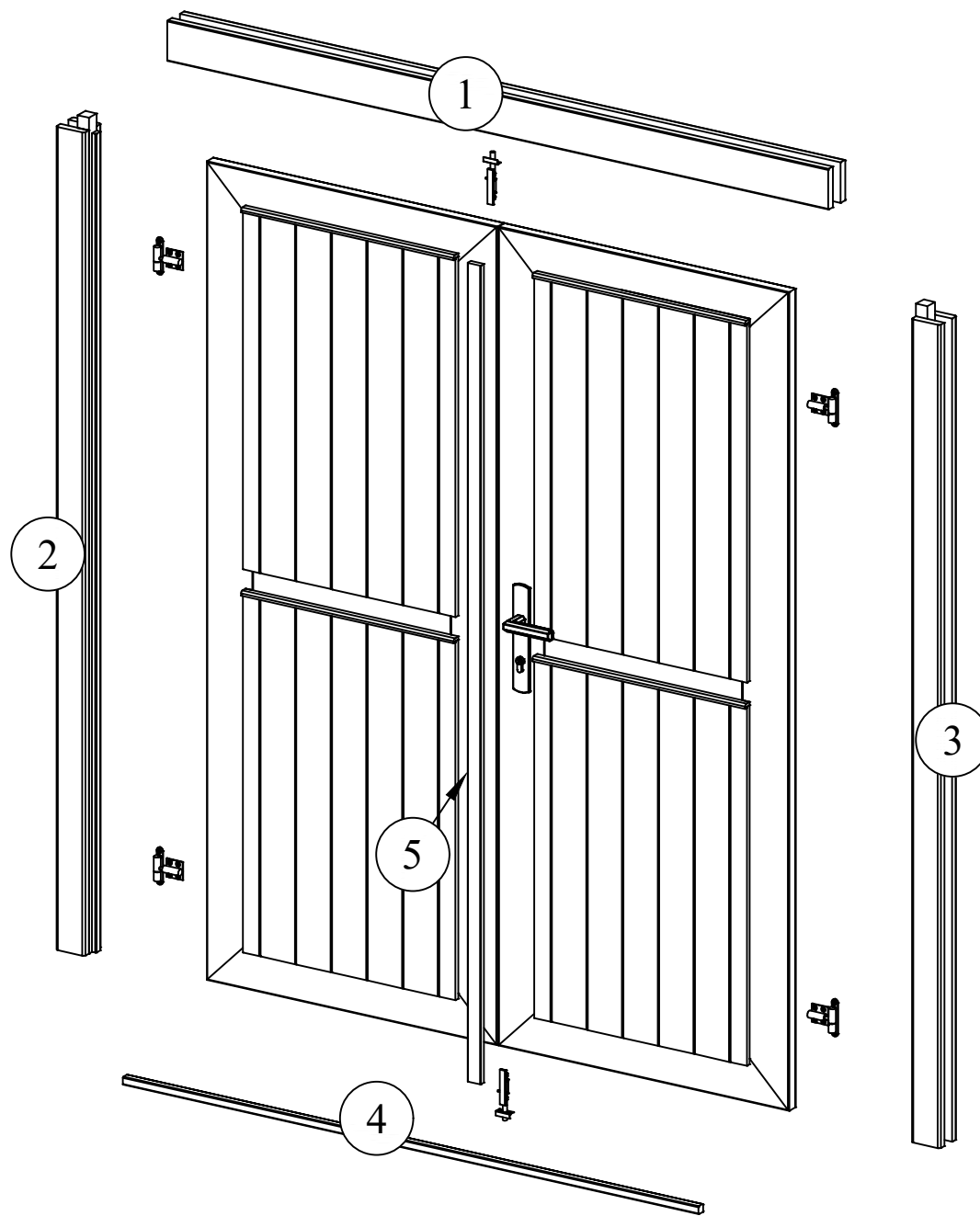

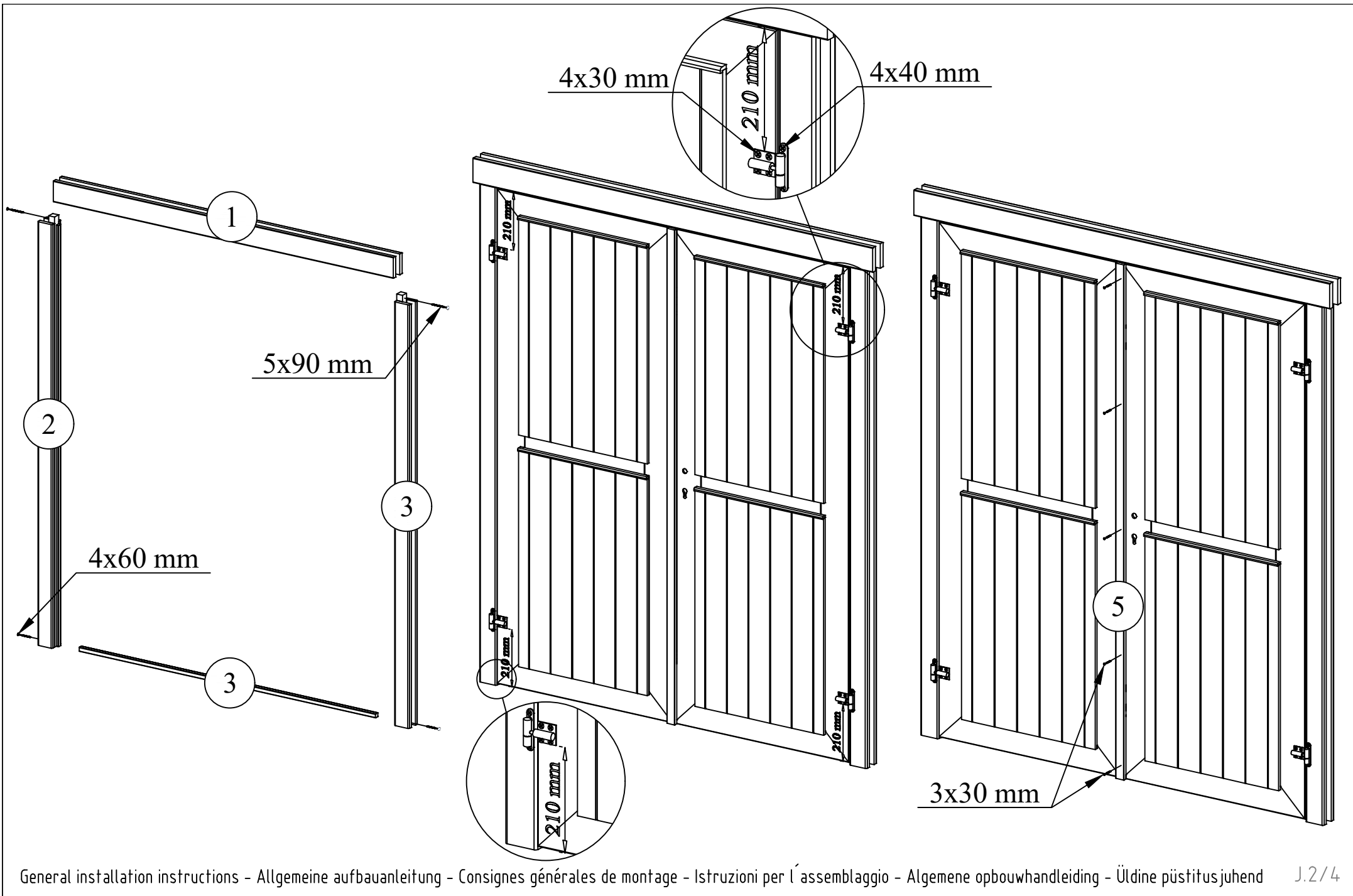

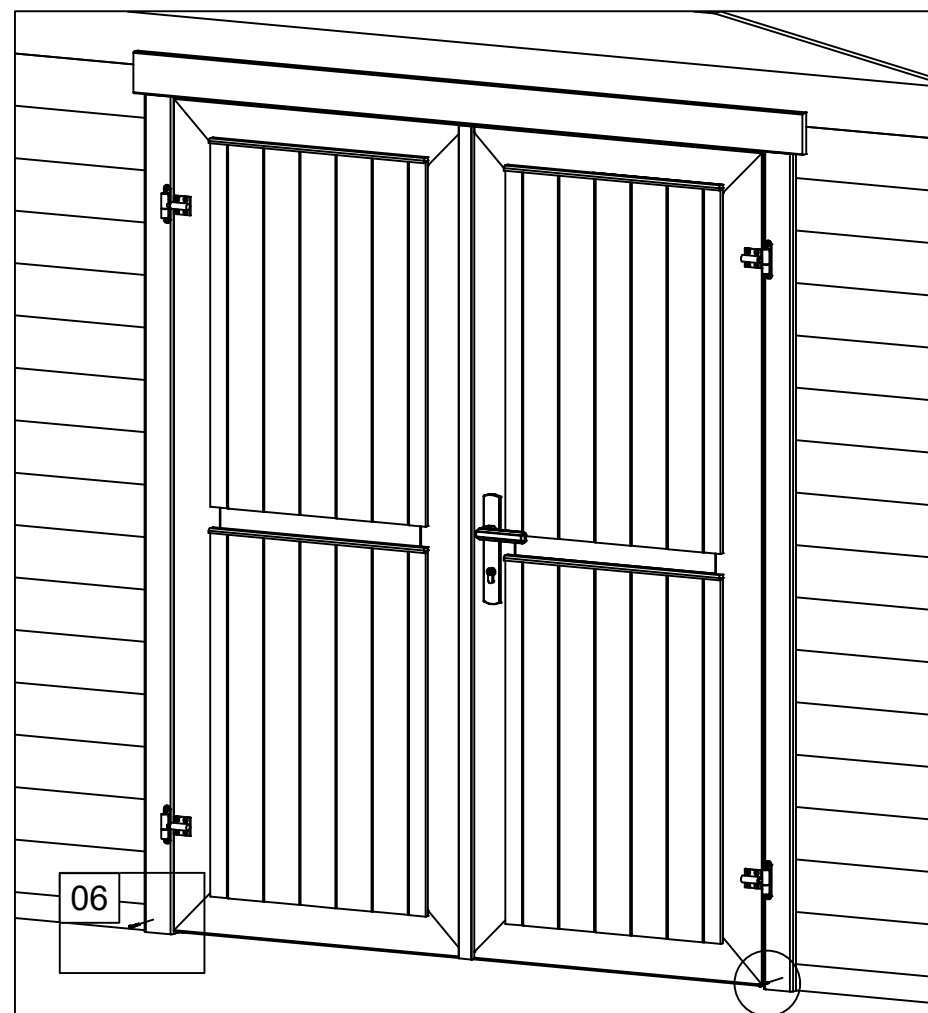
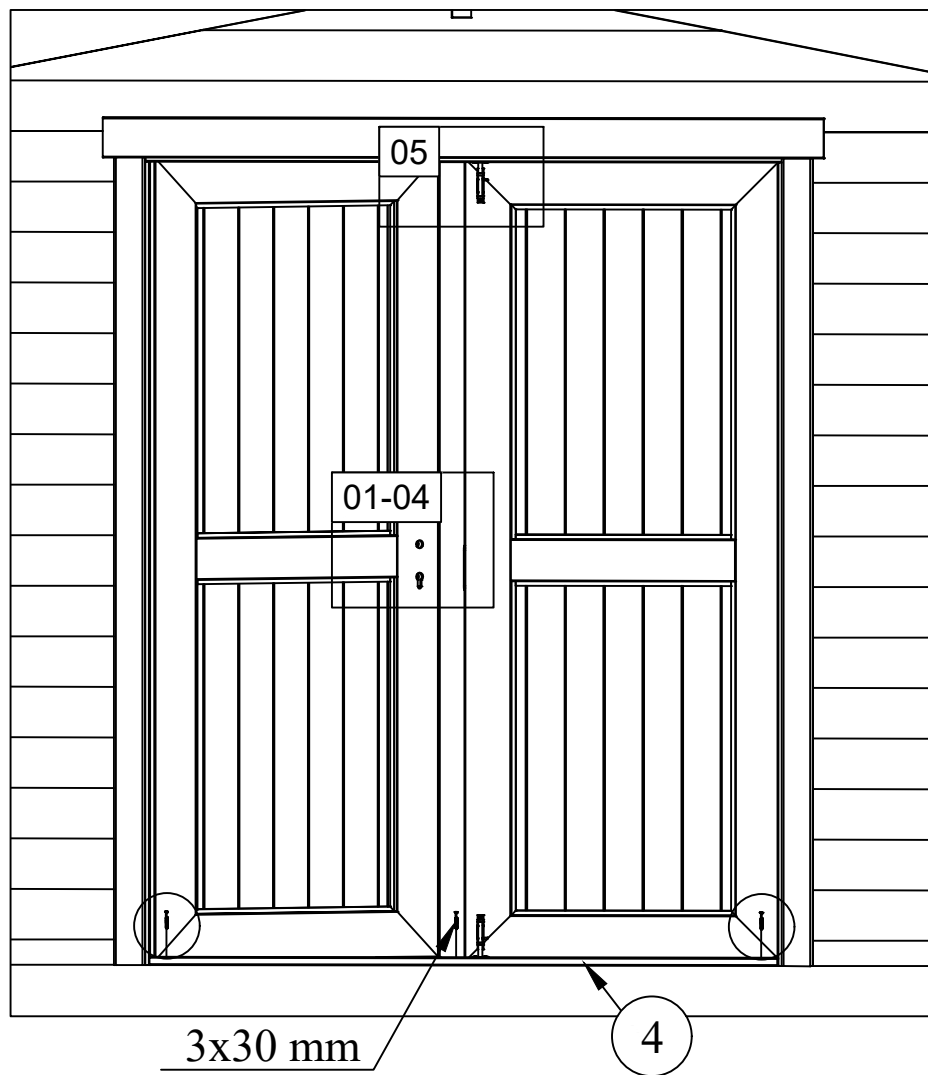

01



04

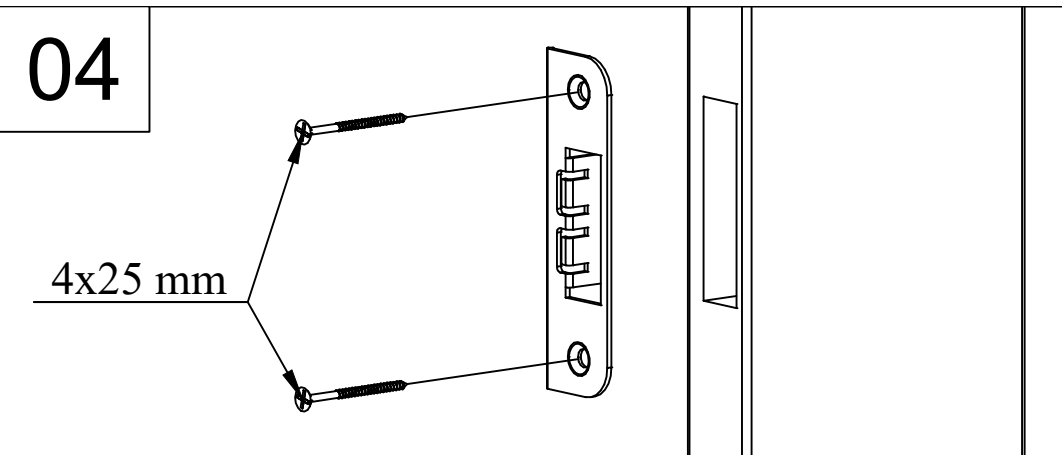

02



05

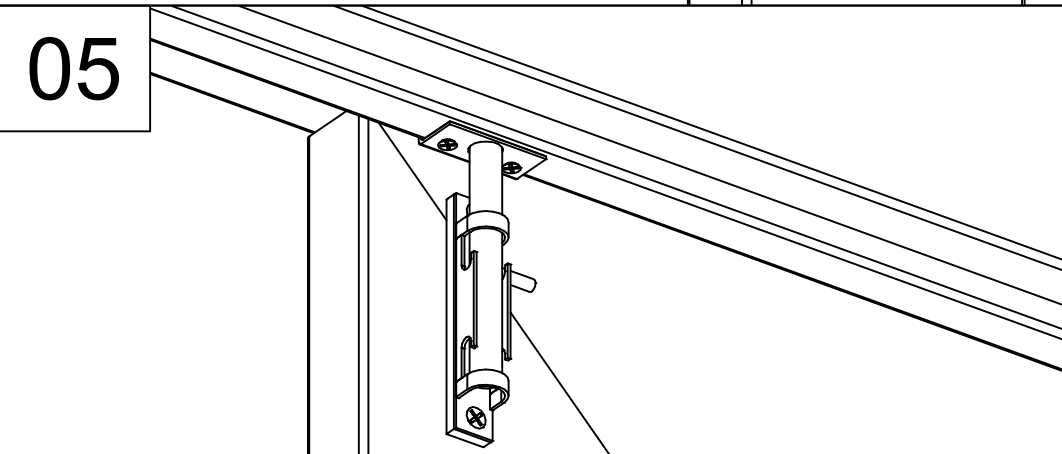

03



06

