

Monteringsanvisning

Växthus

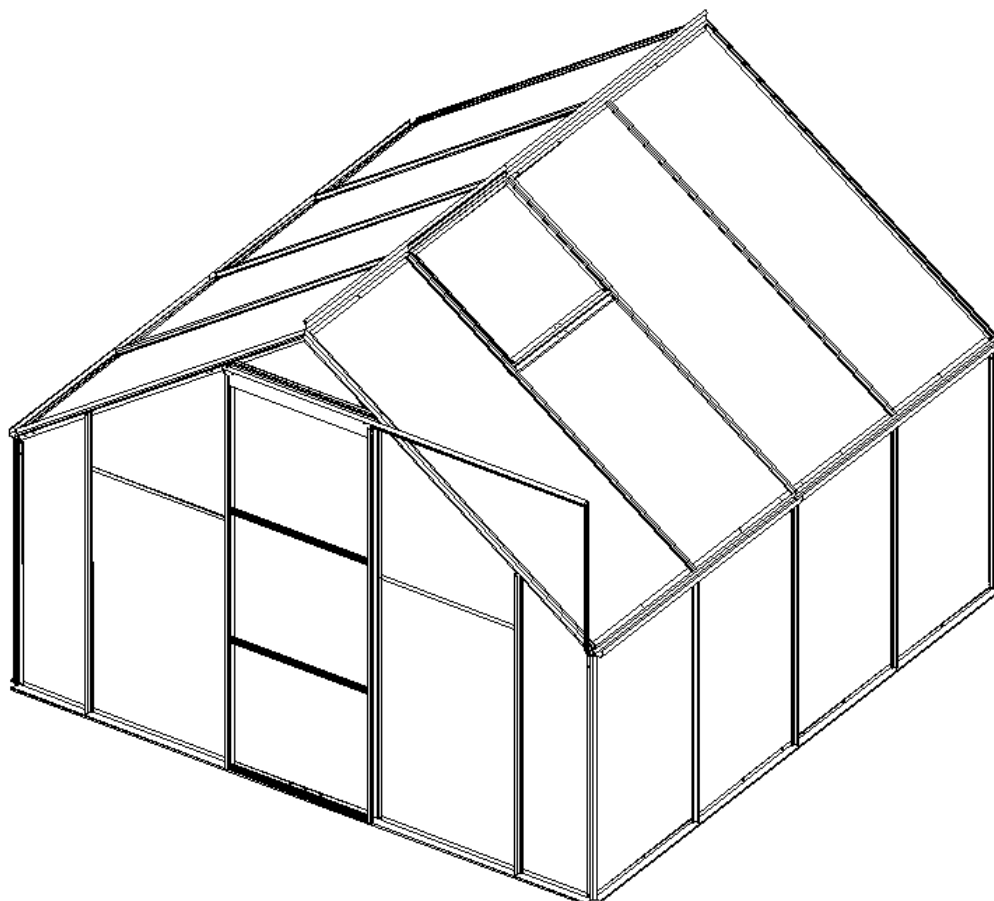

2500mm(L)x2500mm(W)x1950mm(H)

VARNING

Ni måste läsa igenom dessa instruktioner noggrant innan ni påbörjar monteringen.

Obs! Säkerställ innan montering så att inga delar saknas.

Kontrollera både märkningen och antalet med hjälp av listan som finns i denna manual.

Spänn inte åt skruvarna innan det att ramen är färdigmonterad och polykarbonatpanelerna har monterats.

Spara dessa instruktioner för framtida referens.

SÄKERHETSÅD

Vi rekommenderar starkt att ni anvnder skyddshandskar vid monteringen. Frsk inte montera vxthuset i bltt eller blsigt frhllande. Vidrr inte kraftledningarna med aluminiumprofilerna. Br alltid skor och skyddsglasgon nr du arbetar med extruderat aluminium. Kassa alla plastpsar och var noga med att hlla dem borta frn smbarn. Vxthuset mste monteras p ett helt plant underlag. Luta dig inte mot och ge inget tryck mot ramen under monteringen. Hll barn borta frn monteringsplatsen. Montera inte vxthuset p en plats som utstts fr stark vind. Frsk inte montera vxthuset om du trtt, har tagit droger, alkohol eller r bengen till yrsel. Om ni anvnder en trappstege eller elverktyg skerstll att ni fljer tillverkarens skerhetsrd. Varma saker ssom nyligen anvnd grill, skrbrnnare etc fr inte frvaras i vxthuset. Se till att det inte finns ngra dolda rr eller kablar i marken nr ni frankrar.

ALLMNNA RD

Monteringen sker i mnga olika steg, ha ingen brdska och var beredda p att monteringen kan ta upp till 5 timmar. Nr ni vljer en plats till ert vxthus rekommenderas en solig plats utan verhngande grenar. Om ni planerar att fsta vxthuset i ett fundament ssom gjuten grund, anvnd de frborrade hlen i basen. Kontrollera s att samtliga delar finns med innan ni brjar montera. Frvara alla sm delar ssom skruvar och annat i sklar s de inte frsvinner. Notera att drren r hgerhngd och drfr ppnas t hger. Hll taket fritt frn sn, lv och grenar.

VRD & UNDERHLL











Nr ert vxthus behver rengras s anvnd ett bild rengringsmedel och sklj med kallt rent vatten. Anvnd INTE aceton, slipmedel eller andra speciella rengringsmedel.





NDVNDIGA VERKTYG & REDSKAP



- Silikon fr ttning
- Phillips Skruvmejsel
- Syl
- Trappstege
- Mttband
- Stor hammare
- Sax
- Arbetshandskar
- Vattenpass
- Smrjmedel
- Gummihammare
- Metallborr, 2 mm



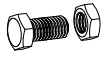
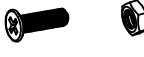
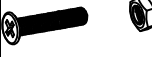

7		1005mm	4
16-1		1496mm	1
16-2		1496mm	1
16-3		1496mm	1
16-4		1496mm	1
6		1215mm	1
6-1		1215mm	1
28		646mm	1
5		1215mm	1
5-1		1215mm	1
4		1218mm	2
4-1		1218mm	2
26		630mm	5
8		1218mm	2
8-1		1218mm	2
17		1218mm	2
27		630mm	1
13		614mm	1
11R		1242mm	2
11L		1242mm	2
19		1005mm	6
20		1479mm	6
10R		1664mm	1
10L		1664mm	1
9R		1648mm	1
9L		1648mm	1

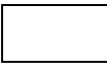
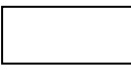
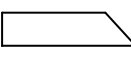
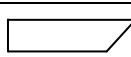
18		1245mm	1
25		407mm	1
21		632mm	1
12		907mm	4
14		636mm	1
22		1178mm	4
23		1316mm	2
15		600mm	5
W1		590mm	1
W2		522mm	2
W3		590mm	1
D1		1623mm	1
D4		1623mm	1
D2		617mm	1
D3		617mm	3

B3		170	
B4		1	
B5		4	
B6		1	
B8		1	
W4		1	
S3		4	
S4		8	
S6		1	
S8		1	

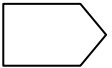
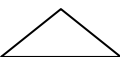
S7R		1	
S7L		1	
F1		10	
F3		1	
F4		134	
F5		4	
F8		1	
F9		1	

P8		13	
P9		7	
P3L		2	
P3R		2	
P10		1	
P2		1	

P6		1	
P7		1	
P1		3	
P4L		2	
P4R		2	

Förmontering

Montera del 6, 6-1 och 28. Dessa bildar D-6.

6 1x	
6-1 1x	
28 1x	
5 1x	
5-1 1x	
26 1x	
4 2x	
4-1 2x	
26 2x	
8 2x	
8-1 2x	
26 2x	
17 2x	
27 1x	
F4 24x	

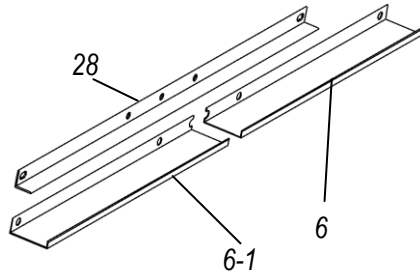

Montera del 5, 5-1 och 26. Dessa bildar D-5.

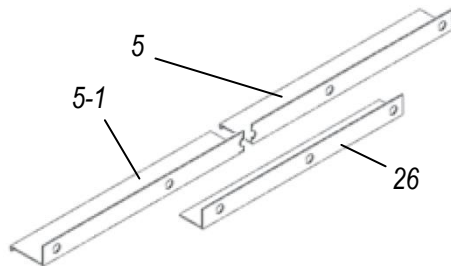

Montera del 4, 4-1 och 26. Dessa bildar D-4.

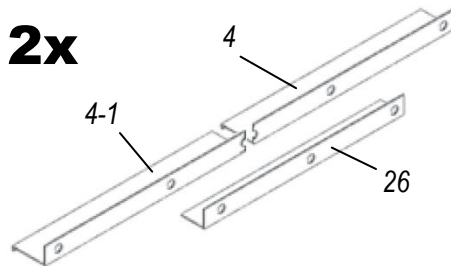

Montera del 8, 8-1 och 26. Dessa bildar D-8.

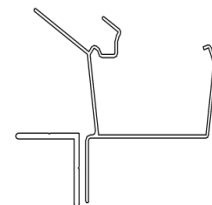
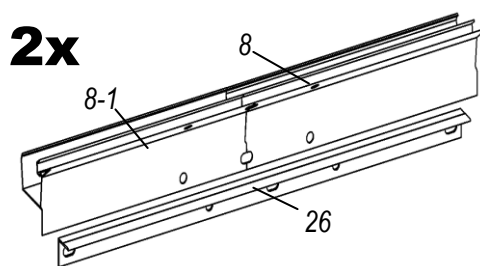

Montera ihop 2 st del 17 med hjälp av del 27. Dessa bildar D-17.

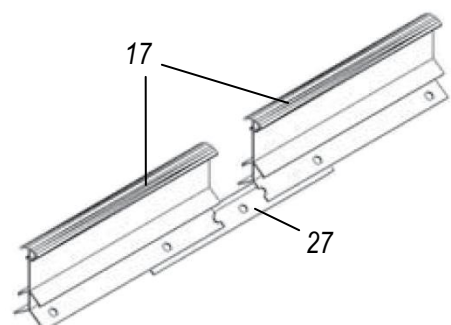

Montering av båda långsidor

#4 2x	
#8 2x	
19 6x	
22 4x	
F4 24x	

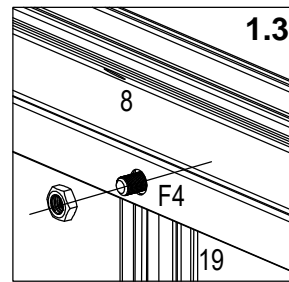
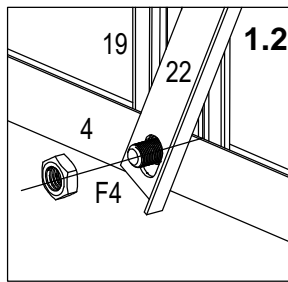
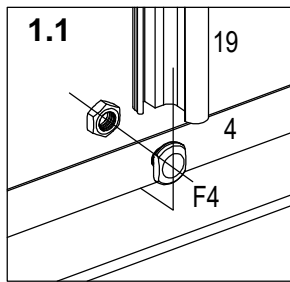
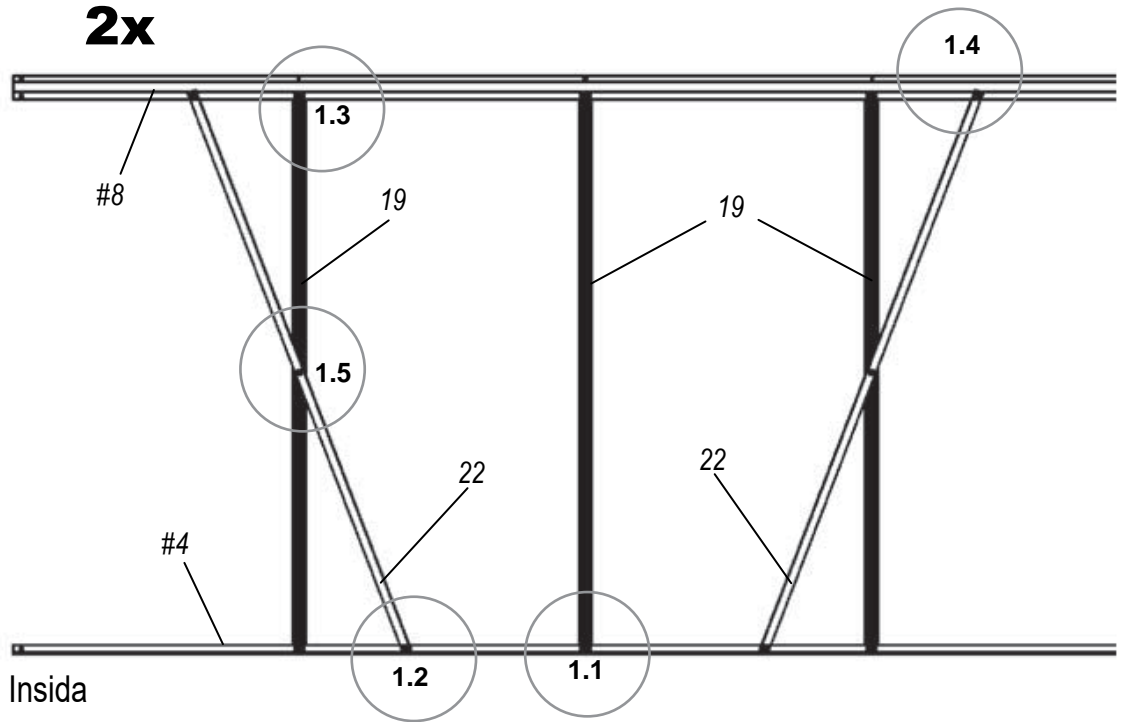



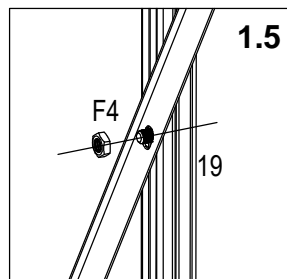
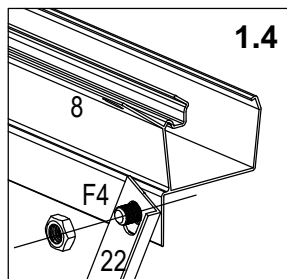









Utvändigt

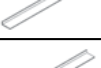

Montering av ena kortsidan

Detta är kortsidan utan dörr



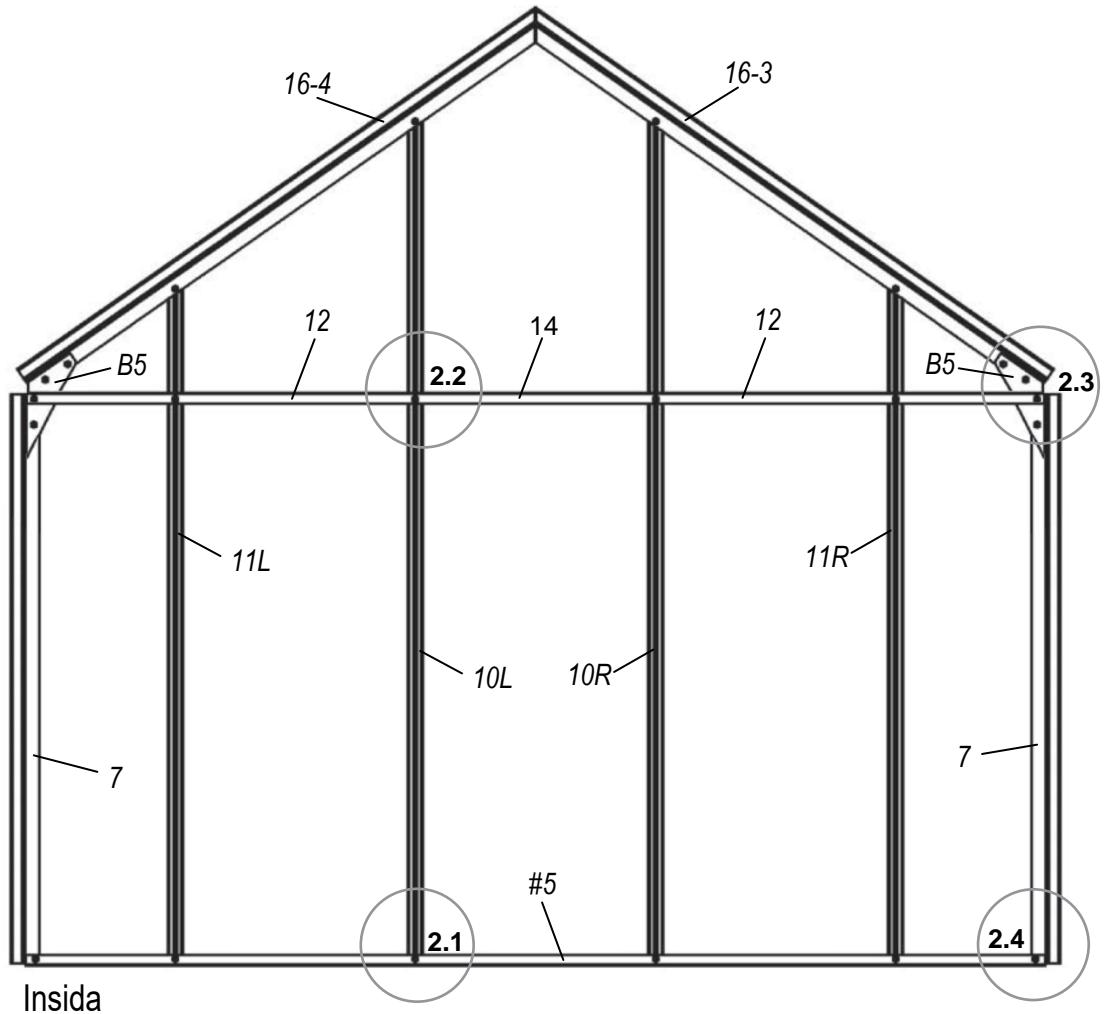



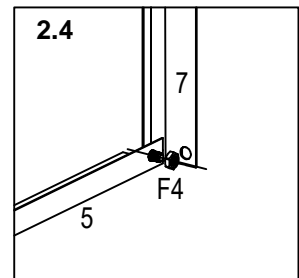
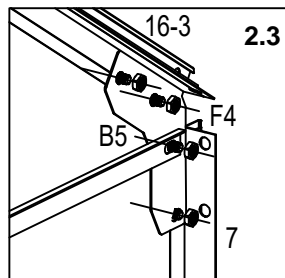
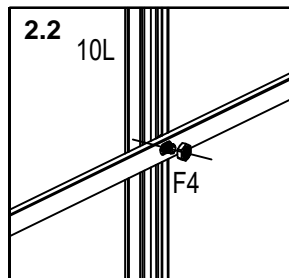
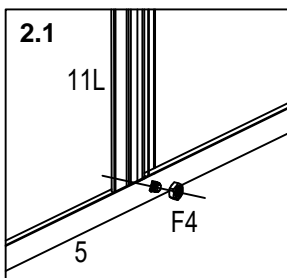







7 2x	
16-3 1x	
16-4 1x	
#5 1x	
10L 1x	
10R 1x	
12 2x	
14 1x	
11L 1x	
11R 1x	
B5 2x	
F4 22x	



Insida



Detta är kortsidan med dörr

7 2x	
16-1 1x	
16-2 1x	
#6 1x	
9L 1x	
9R 1x	
13 1x	
18 1x	
12 2x	
23 2x	
11L 1x	
11R 1x	
B5 2x	
F4 26x	
F5 3x	

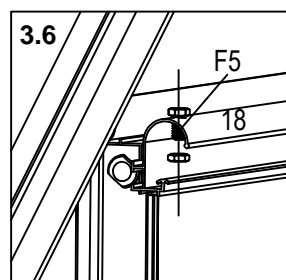
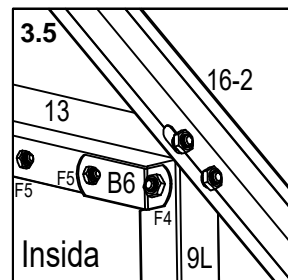
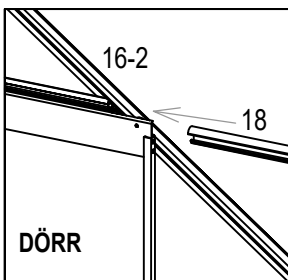
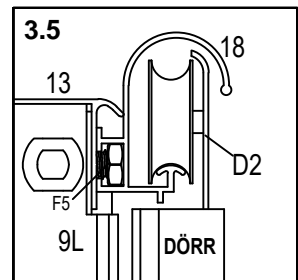
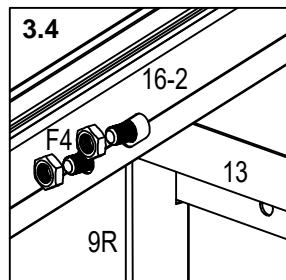
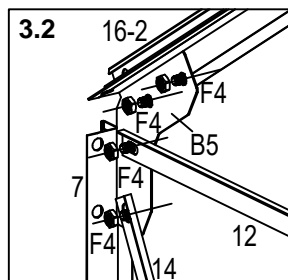
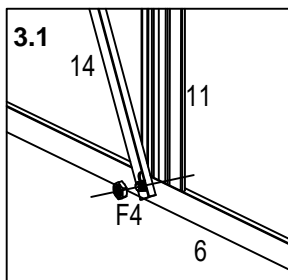
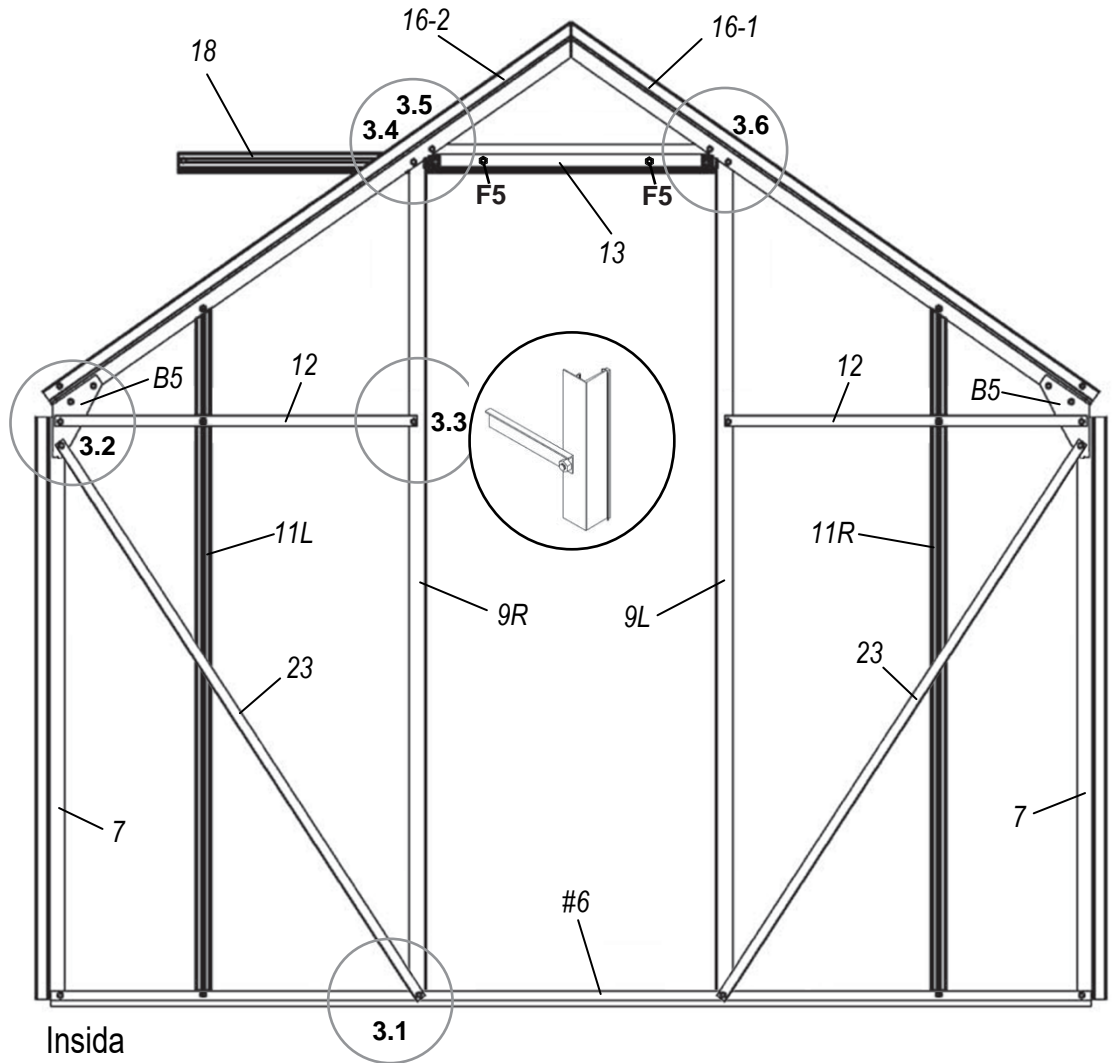





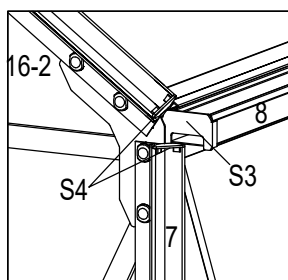
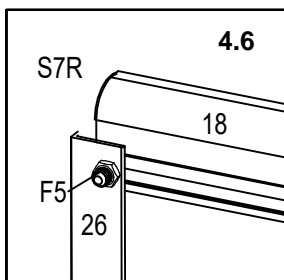
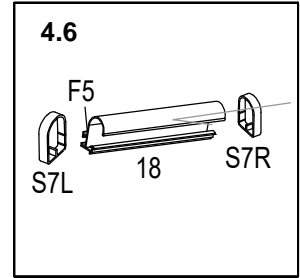
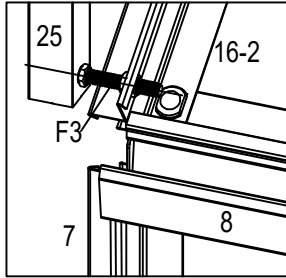
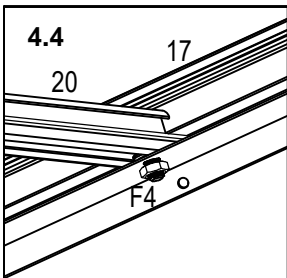
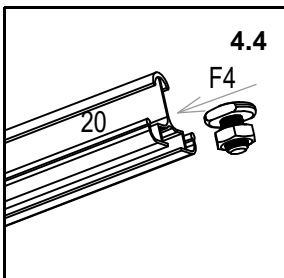
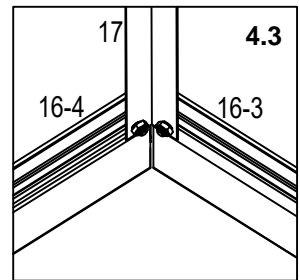
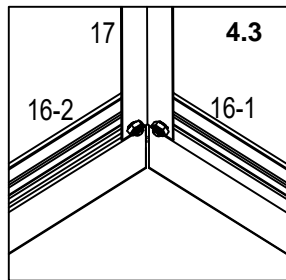
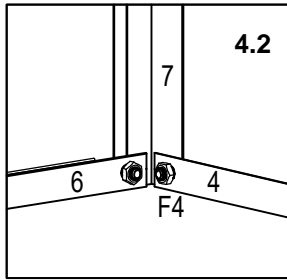
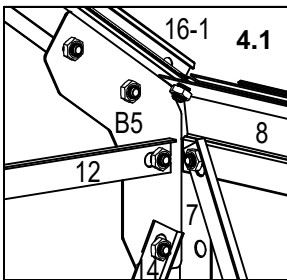
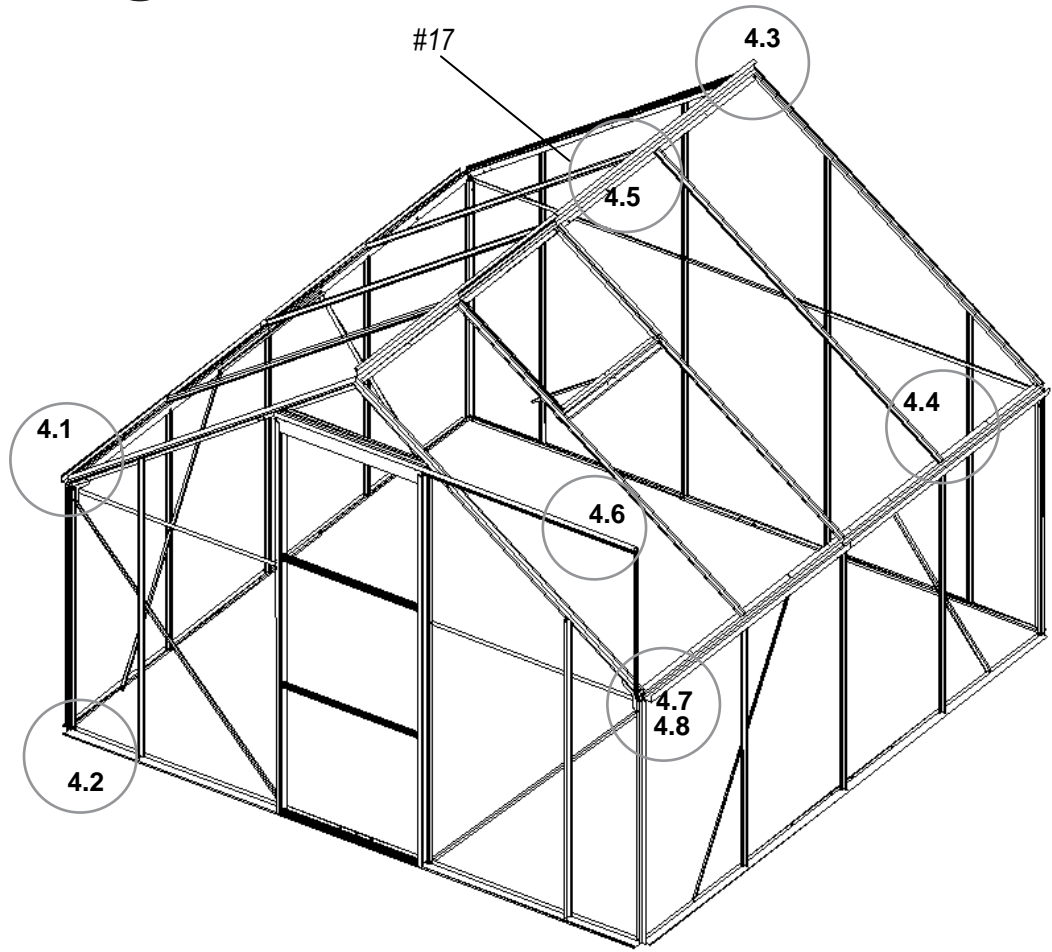

Ihopmontering av kortsidor, långsidor samt takstolar

#17 1x	
20 6x	
25 1x	
F3 1x	
F4 29x	
F5 1x	
S3 4x	
S4 8x	
S7L x1	
S7R x1	



Del 5

Ihopmontering av dörr

Bild	Nr.	Antal
	D1	1
	D4	1
	D2	1
	D3	3
	F1	10
	F5	2

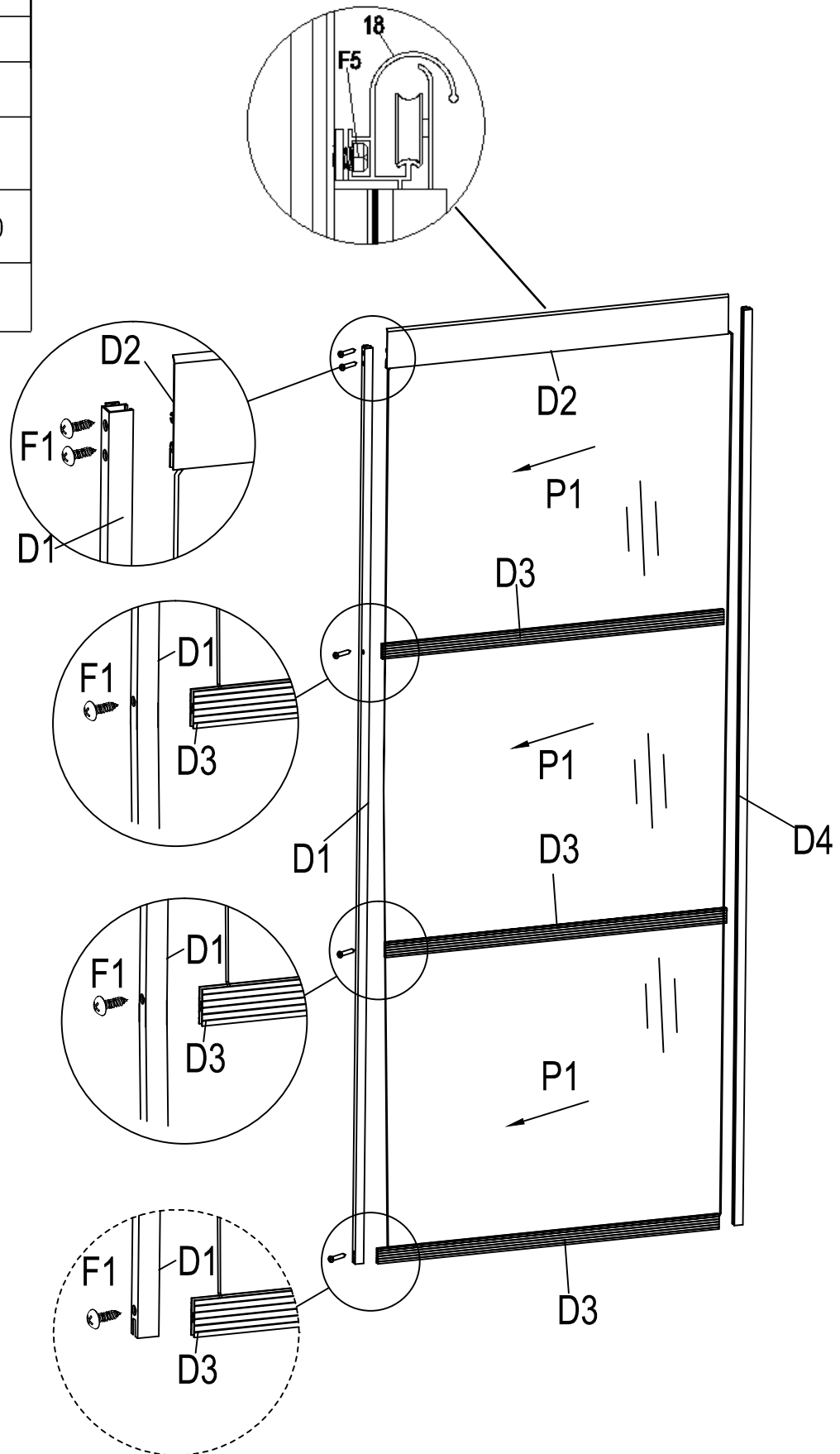

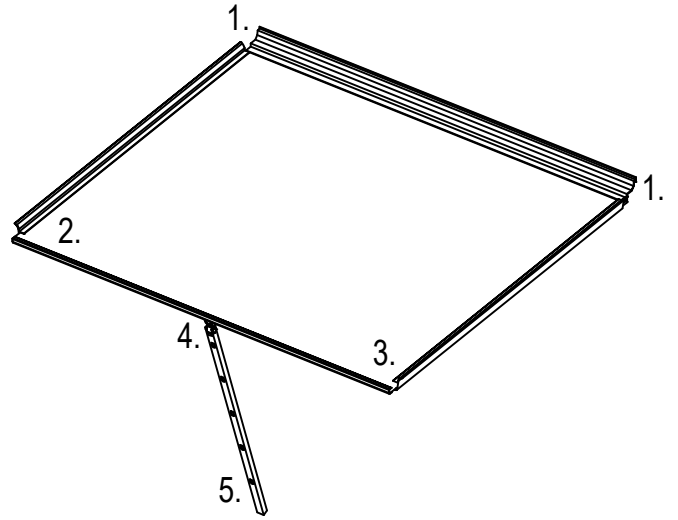
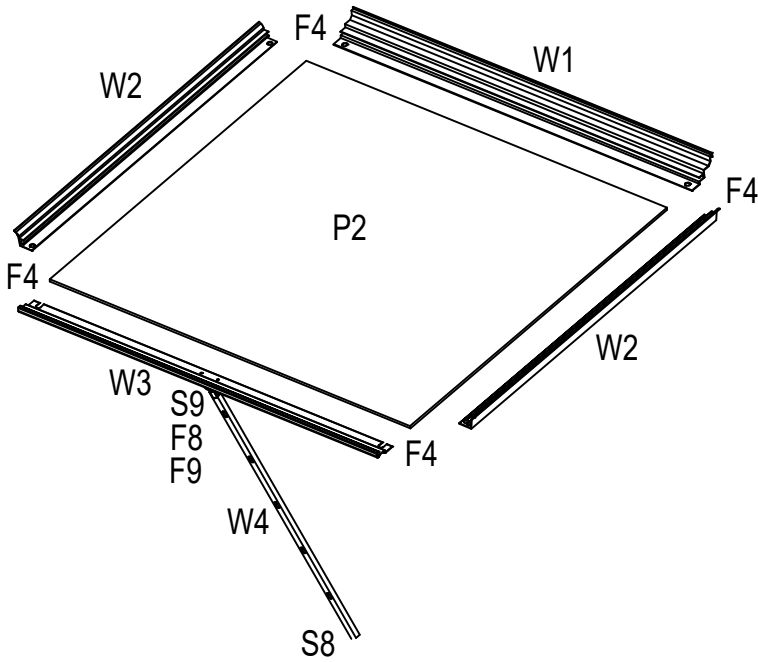

Fönster

21 1x	
W1 1x	
W2 2x	
W3 1x	
B4 1x	
F4 4x	
S8 1x	
S6 1x	
W4 1x	
P2 1x	
B8 1x	
F8 1x	
F9 1x	

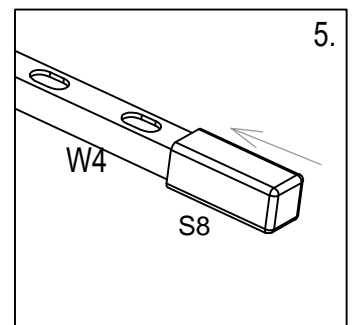
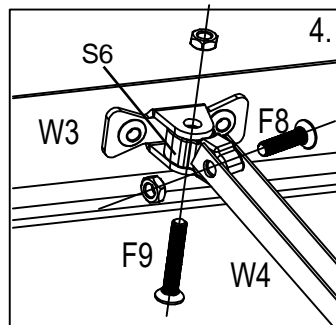
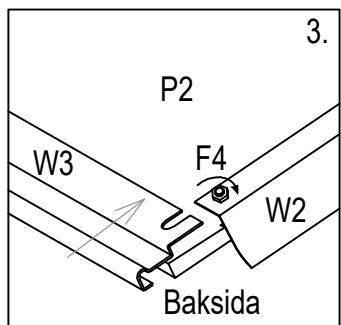
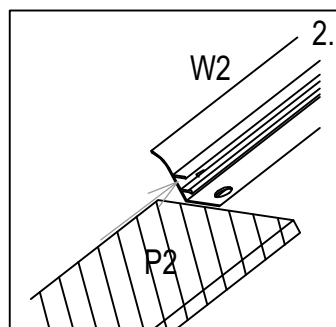
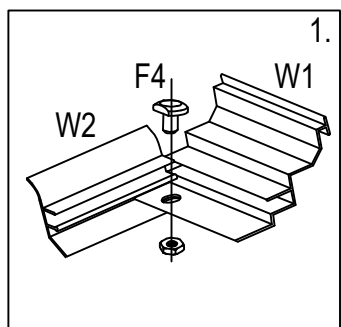
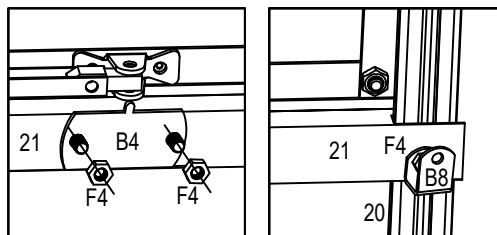

Del 7 Montering av PC-paneler samt dörr och fönster

Obs! Sidan med vit skyddsfilm har UV-skydd och ska monteras utåt (mot solen).

15 5x	
B3 170x	
P8 13x	
P9 7x	
P3L 2x	
P3R 2x	
P10 1x	
P6 1x	
P7 1x	
P1 3x	
P4L 2x	
P4R 2x	

