

# Monteringsanvisning

## Växthus

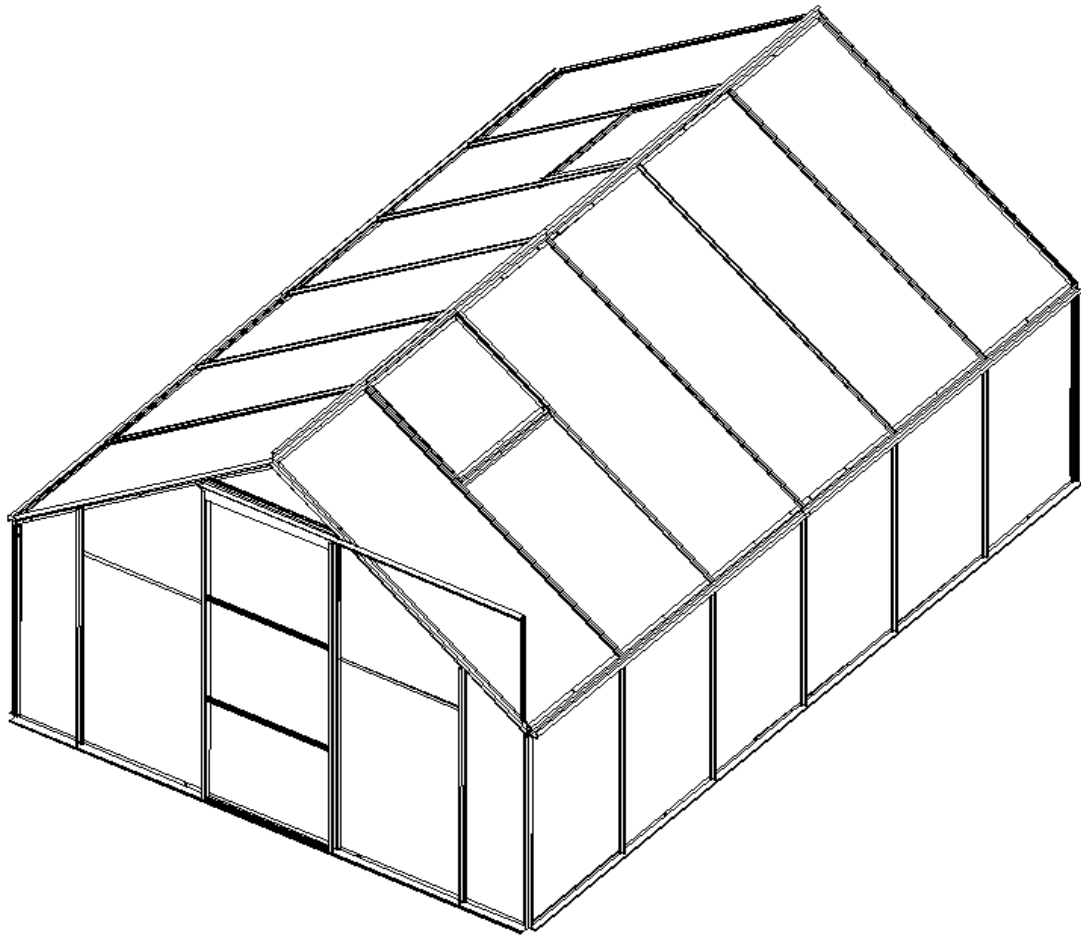

3700mm(L)x2500mm(W)x1950mm(H)

### VARNING

Ni måste läsa igenom dessa instruktioner noggrant innan ni påbörjar monteringen.  
Obs! Säkerställ innan montering så att inga delar saknas.  
Kontrollera både märkningen och antalet med hjälp av listan som finns i denna manual.  
Spänn inte åt skruvarna innan det att ramen är färdigmonterad och polykarbonatpanelerna har monterats.  
Spara dessa instruktioner för framtida referens.

## SÄKERHETSÅD

Vi rekommenderar starkt att ni anvnder skyddshandskar vid monteringen.  
Frsk inte montera vxthuset i bltt eller blsigt frhllande.  
Vidrr inte kraftledningarna med aluminiumprofilerna.  
Br alltid skor och skyddsglasgon nr du arbetar med extruderat aluminium.  
Kassa alla plastpsar och var noga med att hlla dem borta frn smbarn.  
Vxthuset mste monteras p ett helt plant underlag.  
Luta dig inte mot och ge inget tryck mot ramen under monteringen.  
Hll barn borta frn monteringsplatsen.  
Montera inte vxthuset p en plats som utstts fr stark vind.  
Frsk inte montera vxthuset om du trtt, har tagit droger, alkohol eller r bengen till yrsel.  
Om ni anvnder en trappstege eller elverktyg skerstll att ni fljer tillverkarens skerhetsrd.  
Varma saker ssom nyligen anvnd grill, skrbrnnare etc fr inte frvaras i vxthuset.  
Se till att det inte finns ngra dolda rr eller kablar i marken nr ni frankrar.

## ALLMNNA RD

Monteringen sker i mnga olika steg, ha ingen brdska och var beredda p att monteringen kan ta upp till 5 timmar.  
Nr ni vljer en plats till ert vxthus rekommenderas en solig plats utan verhngande grenar. Om ni planerar att fsta vxthuset i ett fundament ssom gjuten grund, anvnd de frborrade hlen i basen. Kontrollera s att samtliga delar finns med innan ni brjar montera. Frvara alla sm delar ssom skruvar och annat i sklar s de inte frsvinner. Notera att drren r hgerhngd och drfr ppnas t hger. Hll taket fritt frn sn, lv och grenar.

## VRD & UNDERHLL











Nr ert vxthus behver rengras s anvnd ett bild rengringsmedel och sklj med kallt rent vatten.  
Anvnd INTE aceton, slipmedel eller andra speciella rengringsmedel.







## NDVNDIGA VERKTYG & REDSKAP





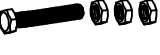

- Silikon fr ttning
- Phillips Skruvmejsel
- Syl
- Trappstege
- Mttband
- Stor hammare
- Sax
- Arbetshandskar
- Vattenpass
- Smrjmedel
- Gummihammare
- Metallborr, 2 mm



7			1005mm	4
16-1			1496mm	1
16-2			1496mm	1
16-3			1496mm	1
16-4			1496mm	1
6			1215mm	1
6-1			1215mm	1
28			646mm	1
5			1215mm	1
5-1			1215mm	1
4			1824mm	2
4-1			1824mm	2
26			630mm	5
8			1824mm	2
8-1			1824mm	2
17			1824mm	2
27			630mm	1
13			614mm	1
11R			1242mm	2
11L				2
19			1005mm	10
20				1479mm
10R			1664mm	1
10L				1664mm
9R			1648mm	1
9L				1648mm

18			1245mm	1
25			407mm	1
21			632mm	2
12			907mm	4
14			636mm	1
22			1178mm	4
23			1316mm	2
15			600mm	5
W1			590mm	2
W2			522mm	4
W3			590mm	2
D1			1623mm	1
D4			1623mm	1
D2			617mm	1
D3			617mm	3

B3		240	
B4		2	
B5		4	
B6		1	
B8		2	
W4		2	
S3		4	
S4		8	
S6		2	
S8		2	

S7R		1	
S7L		1	
F1		10	
F3		1	
F4		182	
F5		4	
F8		2	
F9		2	

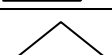
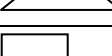
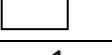
P8		17	
P9		10	
P3L		2	
P3R		2	
P10		2	
P2		2	

P6		1	
P7		1	
P1		3	
P4L		2	
P4R		2	

Montera del 6, 6-1 och 28. Dessa bildar D-6.

<b>6</b> 1x	
<b>6-1</b> 1x	
<b>28</b> 1x	
<b>5</b> 1x	
<b>5-1</b> 1x	
<b>26</b> 1x	
<b>4</b> 2x	
<b>4-1</b> 2x	
<b>26</b> 2x	
<b>8</b> 2x	
<b>8-1</b> 2x	
<b>26</b> 2x	
<b>17</b> 2x	
<b>27</b> 1x	
<b>F4</b> 24x	

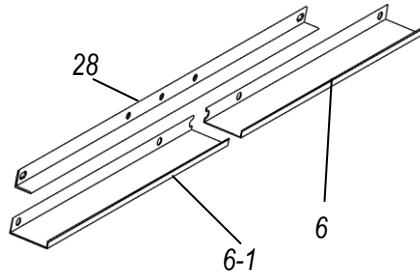

Montera del 5, 5-1 och 26. Dessa bildar D-5.

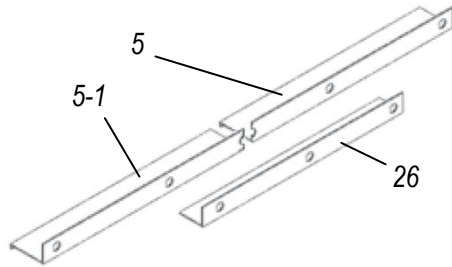

Montera del 4, 4-1 och 26. Dessa bildar D-4.

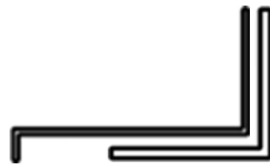
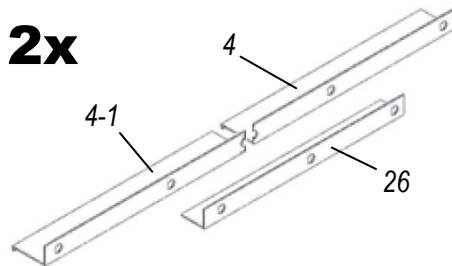



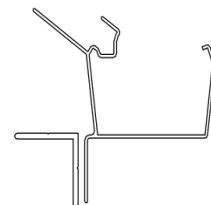
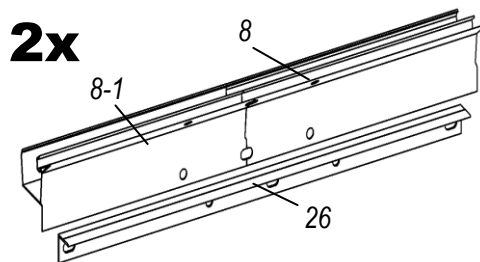

Montera del 8, 8-1 och 26. Dessa bildar D-8.

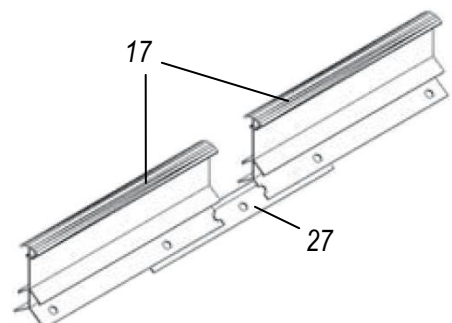

Montera ihop 2 st del 17 med hjälp av del 27. Dessa bildar D-17



#4 2x	
#8 2x	
19 10x	
22 4x	
F4 32x	

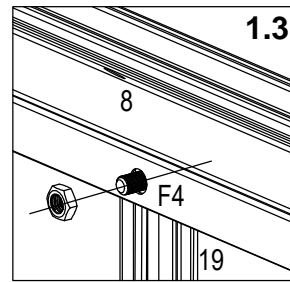
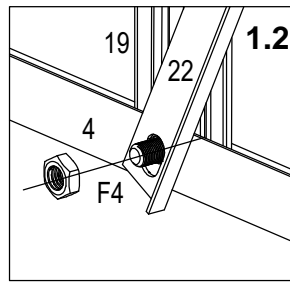
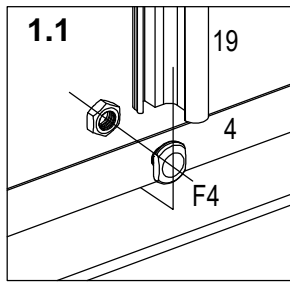
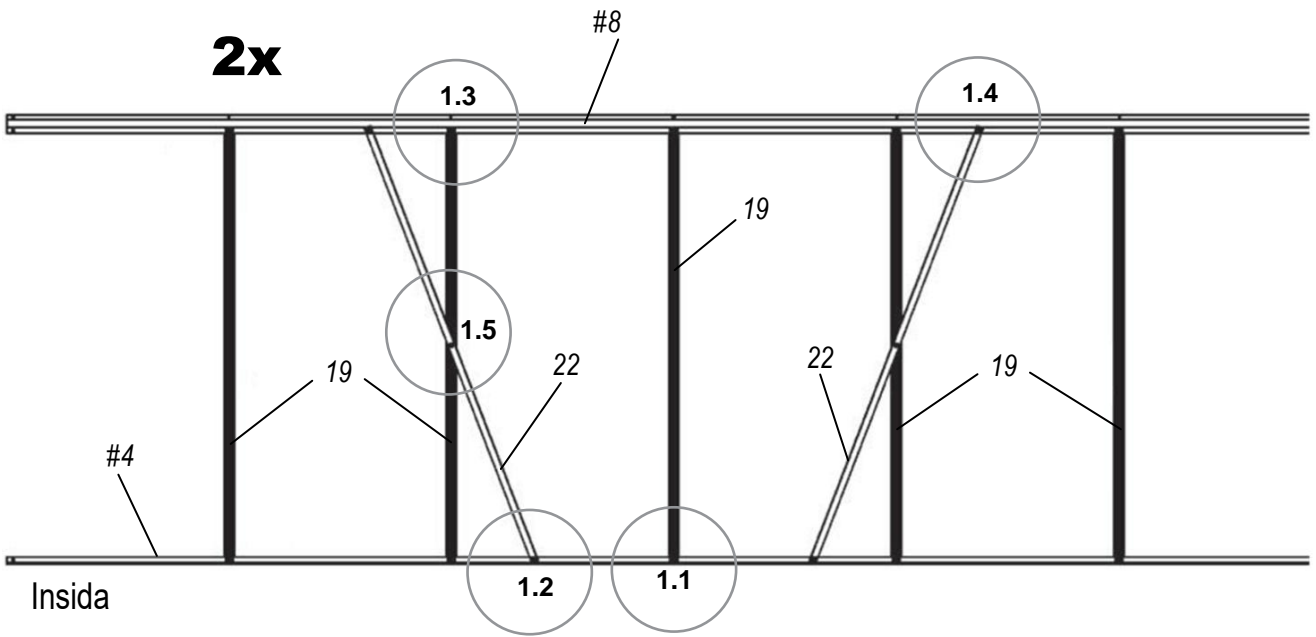

Utvändigt

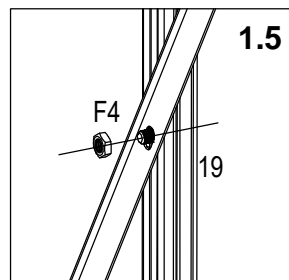
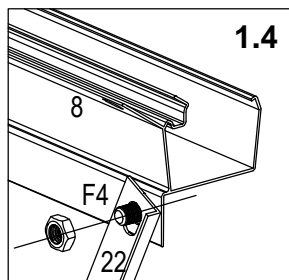

<b>7</b> 2x	
<b>16-3</b> 1x	
<b>16-4</b> 1x	
<b>#5</b> 1x	
<b>10L</b> 1x	
<b>10R</b> 1x	
<b>12</b> 2x	
<b>14</b> 1x	
<b>11L</b> 1x	
<b>11R</b> 1x	
<b>B5</b> 2x	
<b>F4</b> 22x	

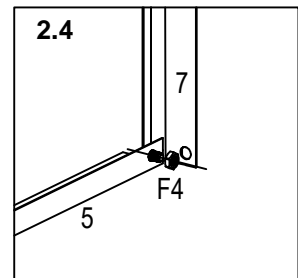
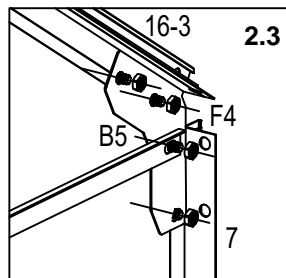
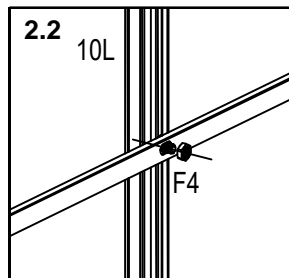
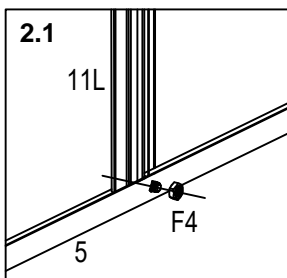
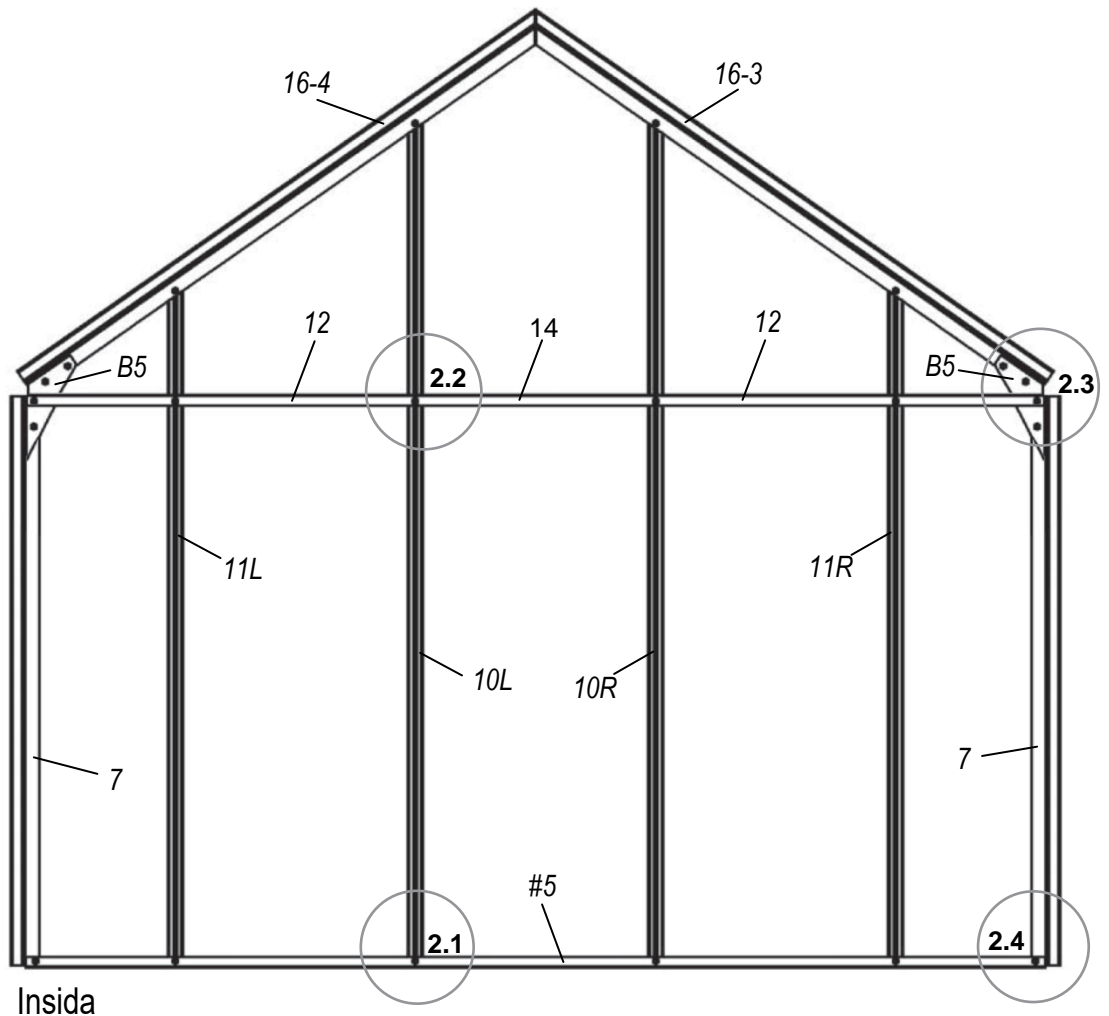

<b>7</b> 2x	
<b>16-1</b> 1x	
<b>16-2</b> 1x	
<b>#6</b> 1x	
<b>9L</b> 1x	
<b>9R</b> 1x	
<b>13</b> 1x	
<b>18</b> 1x	
<b>12</b> 2x	
<b>23</b> 2x	
<b>11L</b> 1x	
<b>11R</b> 1x	
<b>B5</b> 2x	
<b>F4</b> 26x	
<b>F5</b> 2x	
<b>F2</b> 1x	

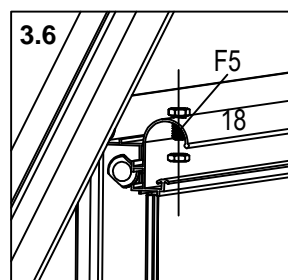
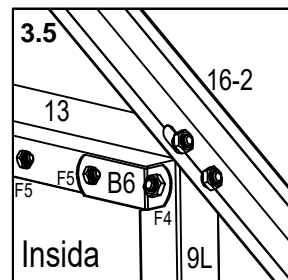
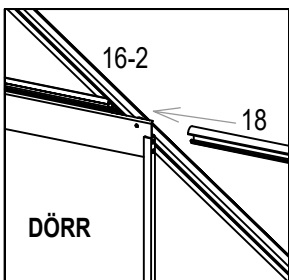
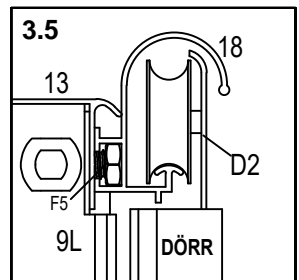
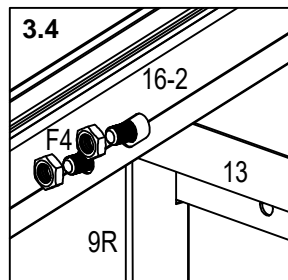
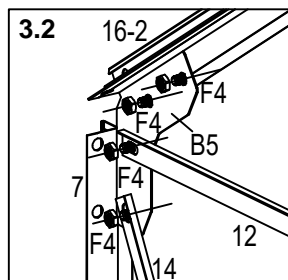
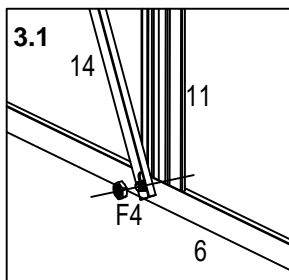
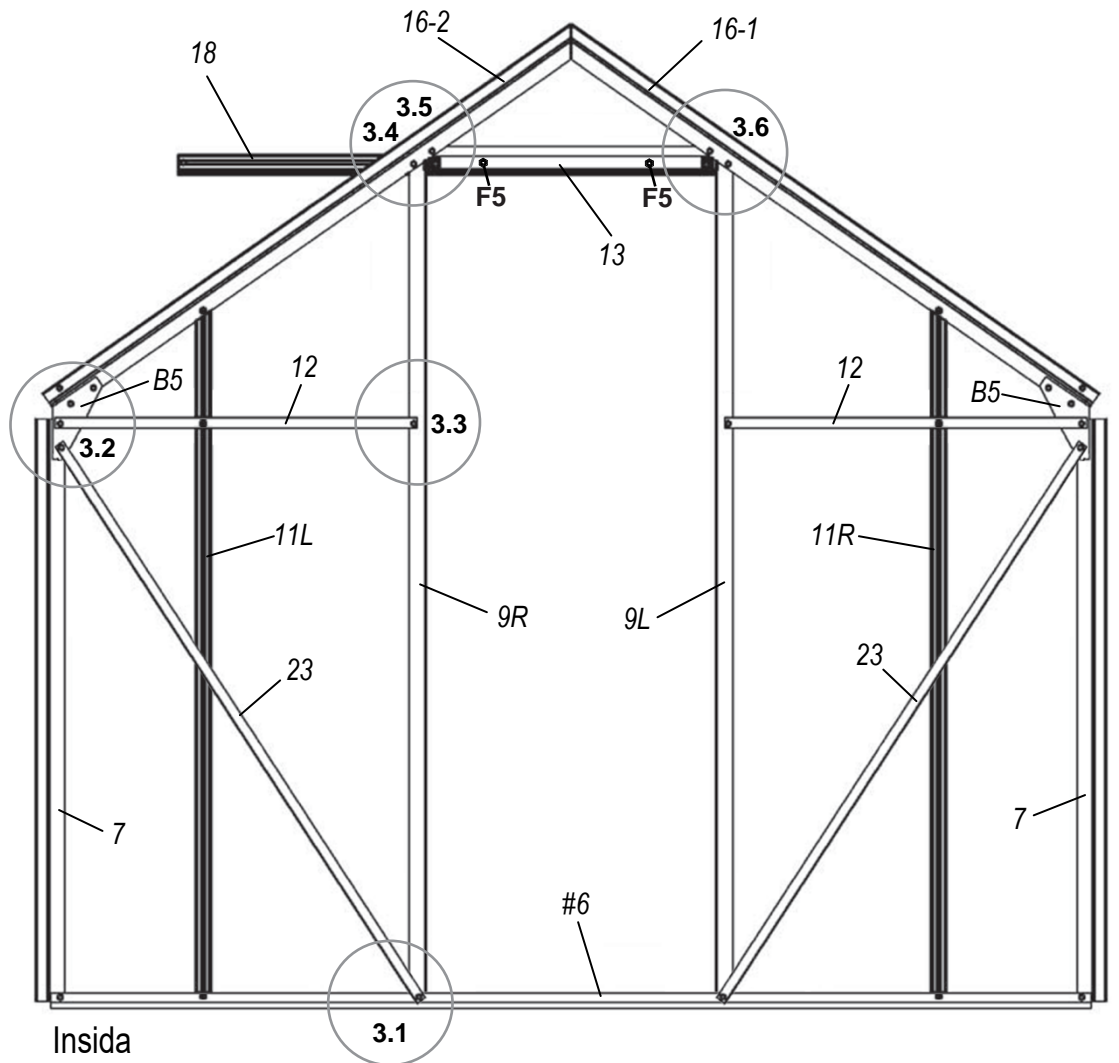



#17	1x	
20	10x	
25	1x	
F3	1x	
F4	37x	
F5	1x	
S3	4x	
S4	8x	
S7L x1		
S7R x1		

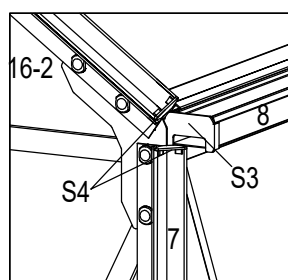
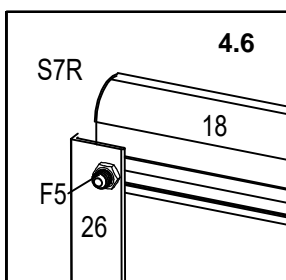
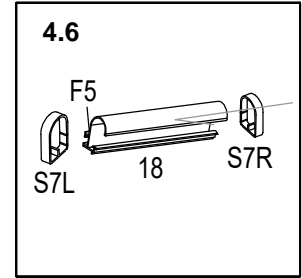
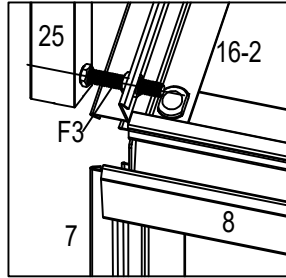
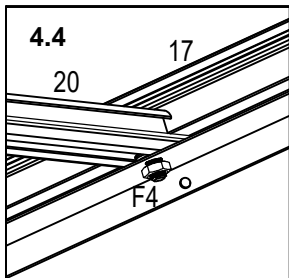
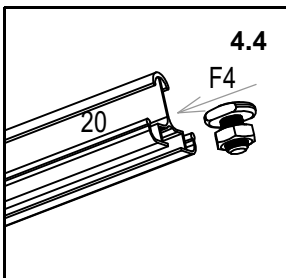
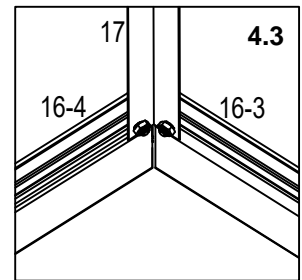
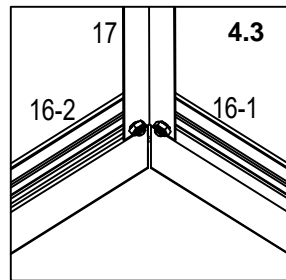
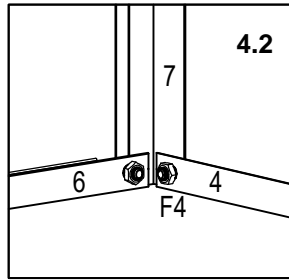
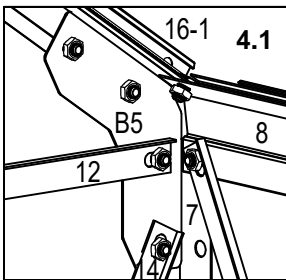
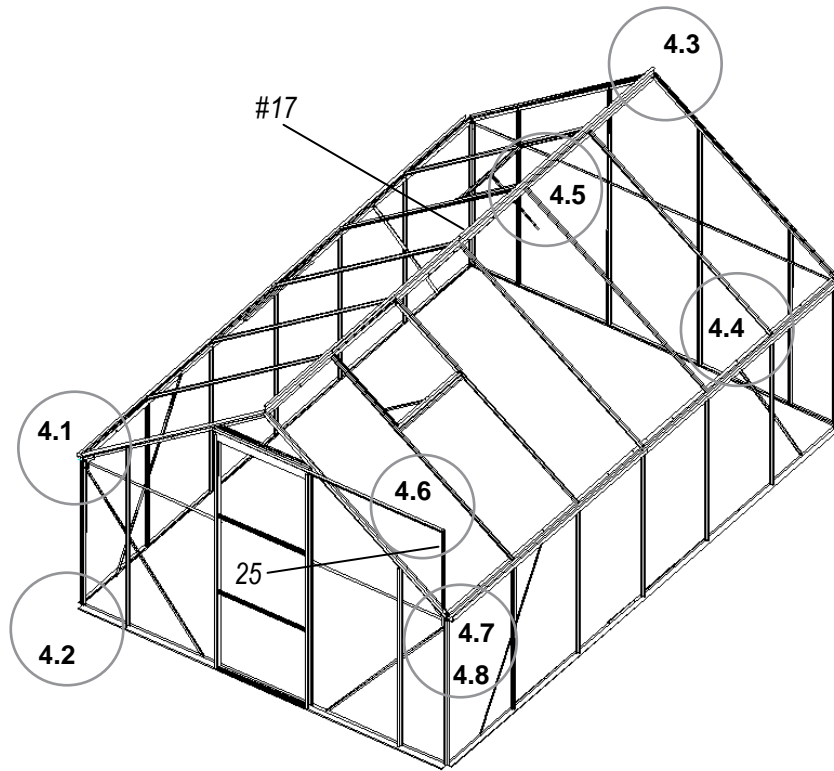

# DÖRR

Bild	Nr.	Antal
	D1	1
	D4	1
	D2	1
	D3	3
	F1	10
	F5	2

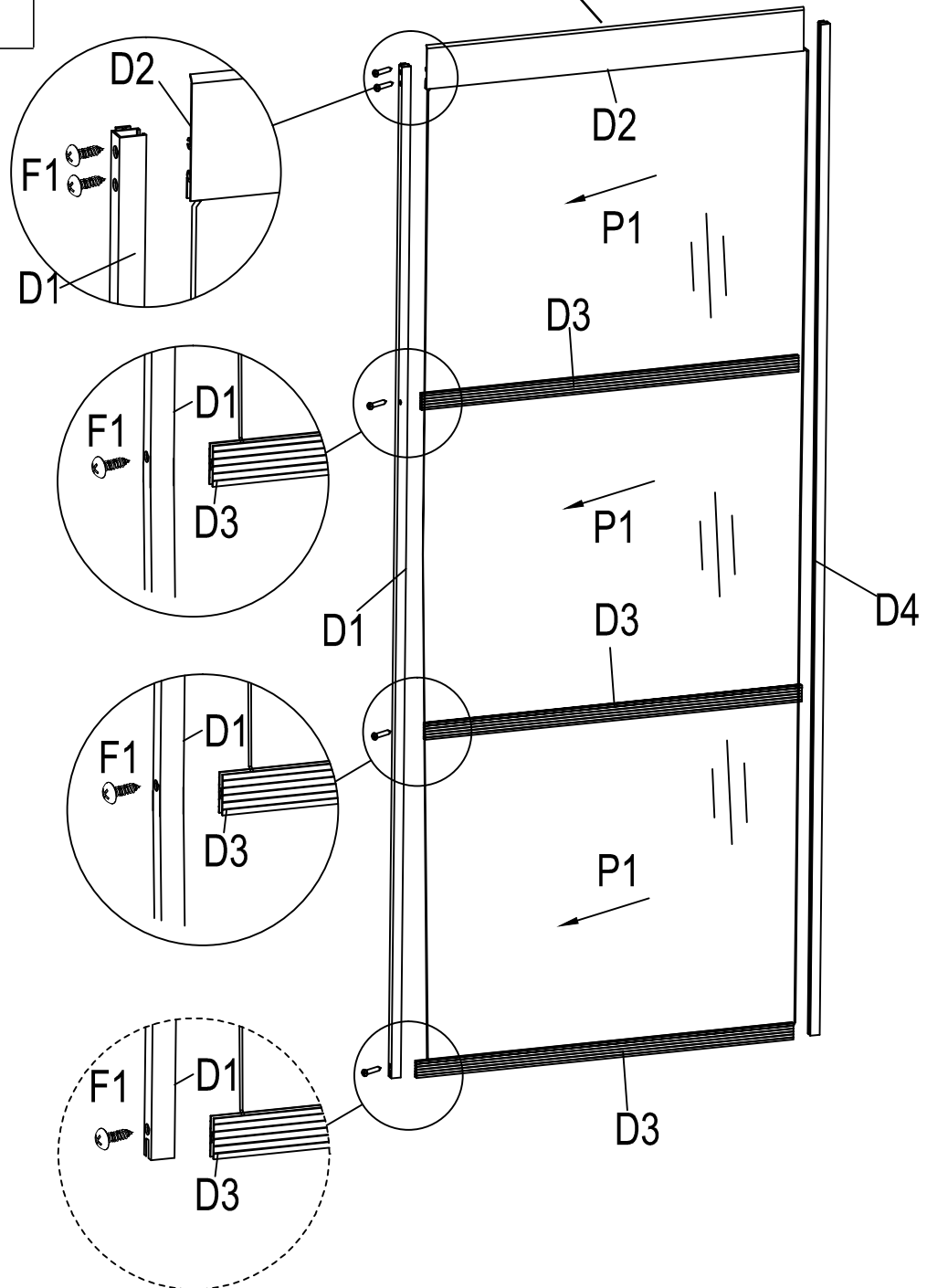
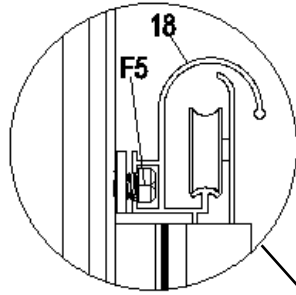

# FÖNSTER

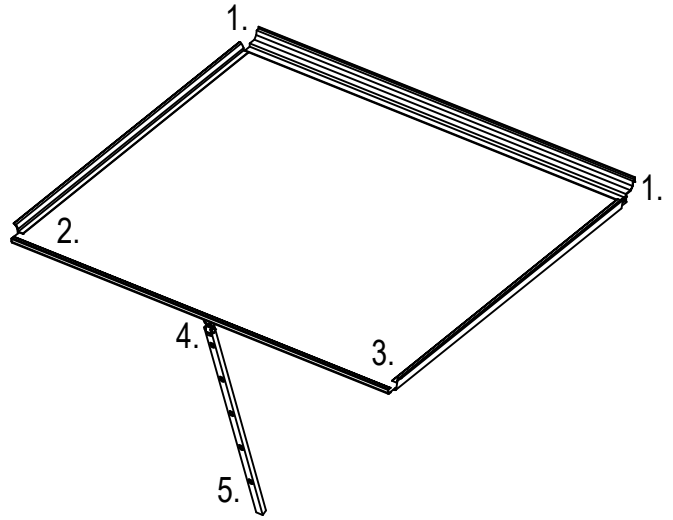
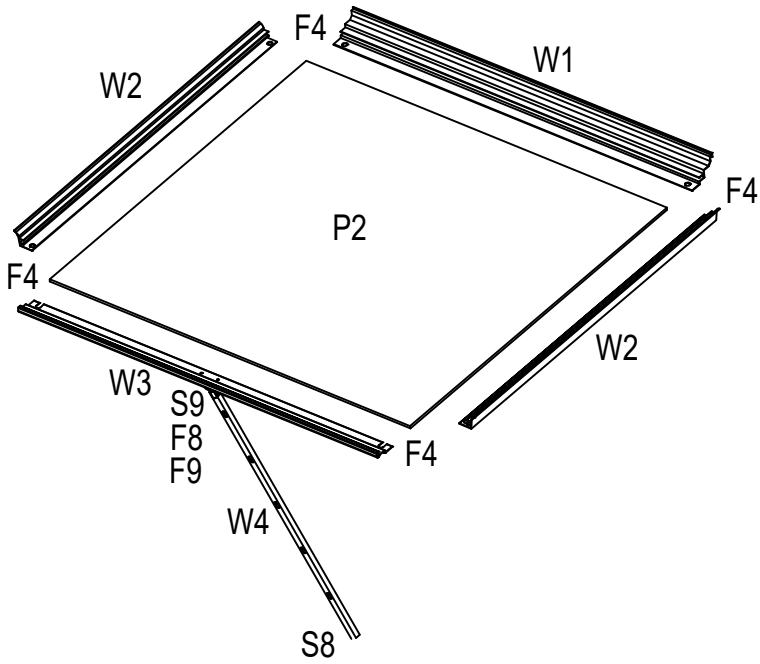

## Fönster

<b>21</b> 1x	
<b>W1</b> 1x	
<b>W2</b> 2x	
<b>W3</b> 1x	
<b>B4</b> 1x	
<b>F4</b> 4x	
<b>S8</b> 1x	
<b>S6</b> 1x	
<b>W4</b> 1x	
<b>P2</b> 1x	
<b>B8</b> 1x	
<b>F8</b> 1x	
<b>F9</b> 1x	

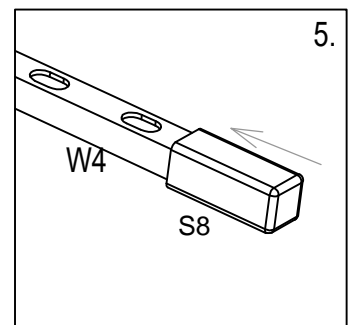
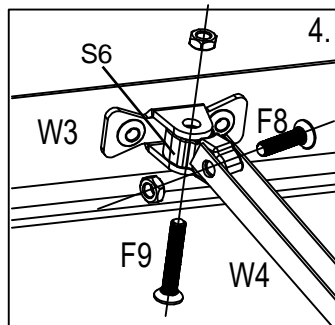
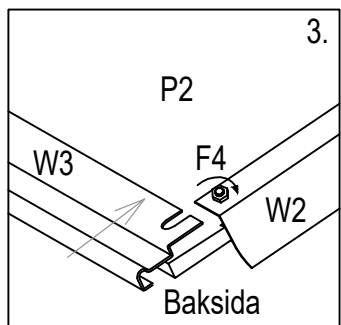
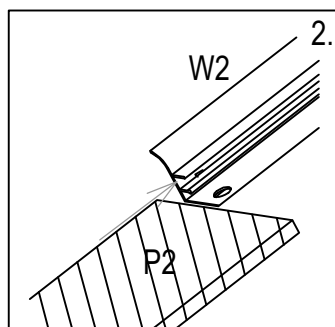
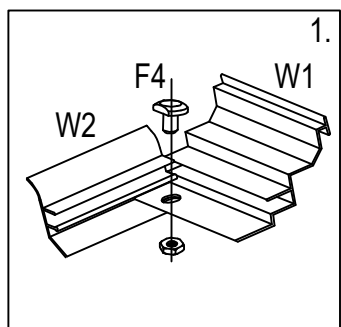
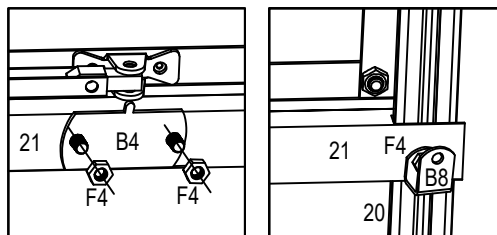

<b>15</b> 5x	
<b>B3</b> 240x	
<b>P8</b> 17x	
<b>P9</b> 10x	
<b>P3L</b> 2x	
<b>P3R</b> 2x	
<b>P10</b> 2x	
<b>P6</b> 1x	
<b>P7</b> 1x	
<b>P1</b> 3x	
<b>P4L</b> 2x	
<b>P4R</b> 2x	

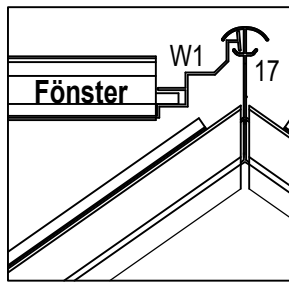
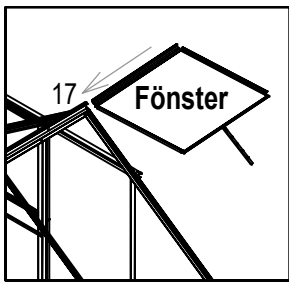

Obs! Sidan med vit skyddsfilm har UV-skydd och ska monteras utåt (mot solen).

