

Monteringsanvisning

Bas till växthus

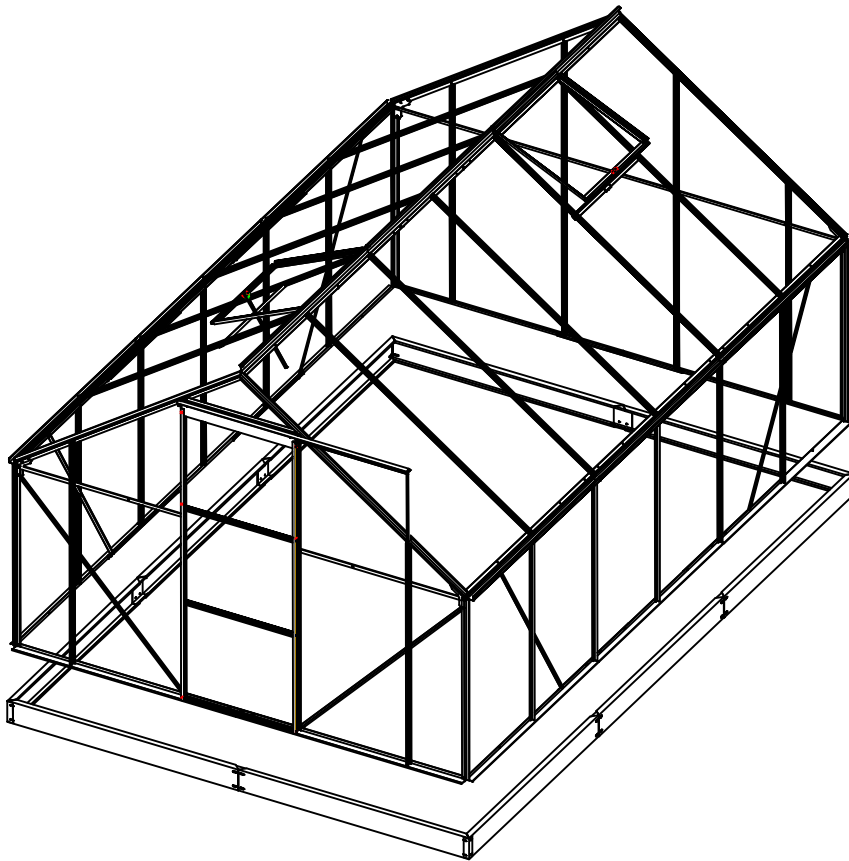

3700mm(L)x2500mm(W)x1950mm(H)

VIKTIGT!





Ni måste läsa igenom dessa instruktioner noggrant innan ni påbörjar monteringen.

Obs! Säkerställ innan montering så att inga delar saknas.

Kontrollera både märkningen och antalet med hjälp av listan som finns i denna manual.

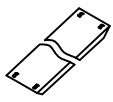
Spänn inte åt skruvarna innan det att ramen är färdigmonterad och polykarbonatpanelerna har monterats.

Spara dessa instruktioner för framtida referens.

Bild	Nr.	Antal
	2	8
	2-1	2
	3	4
	29	6
	F3	40





Bild	Nr.	Antal
	B2	26





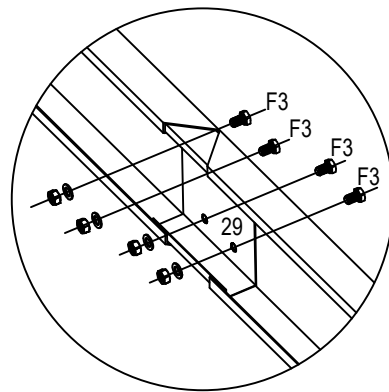
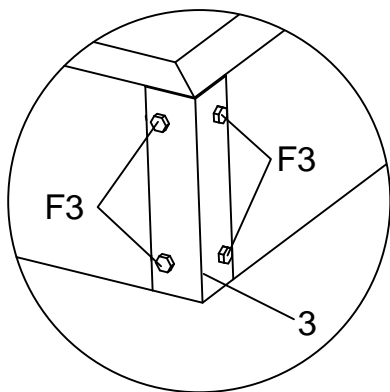
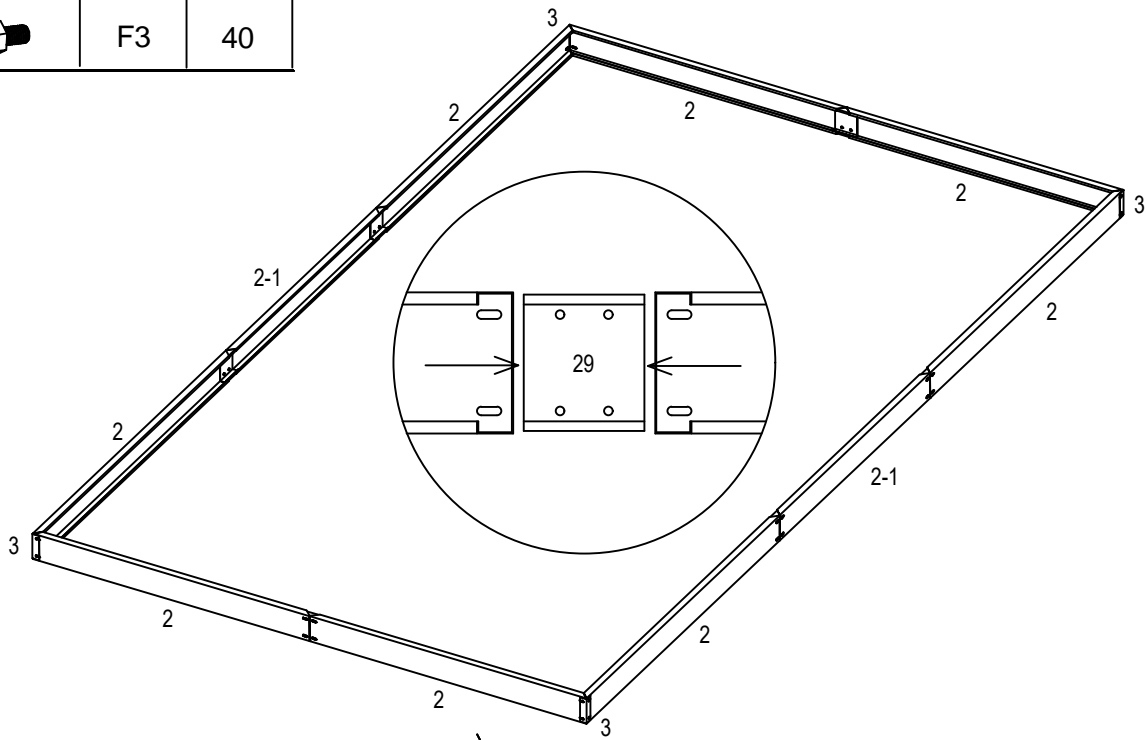

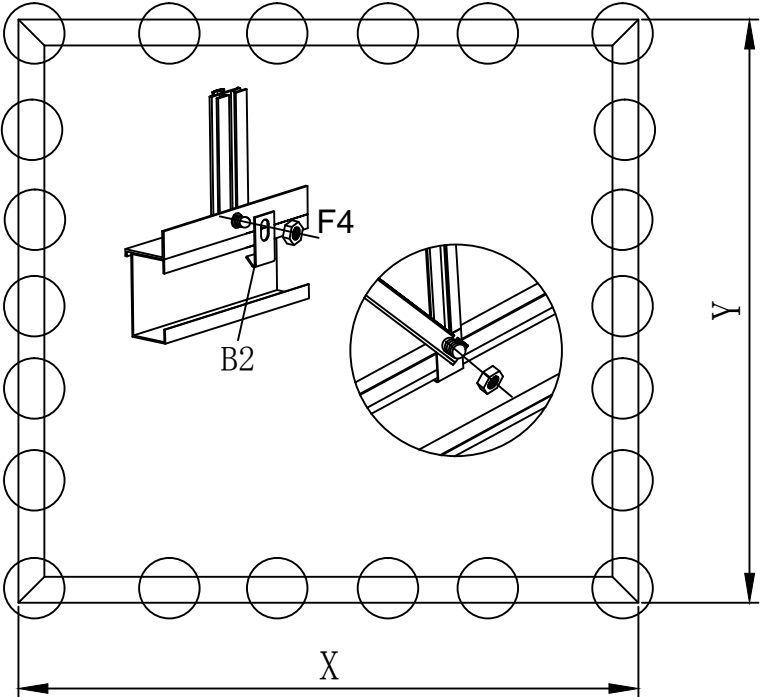
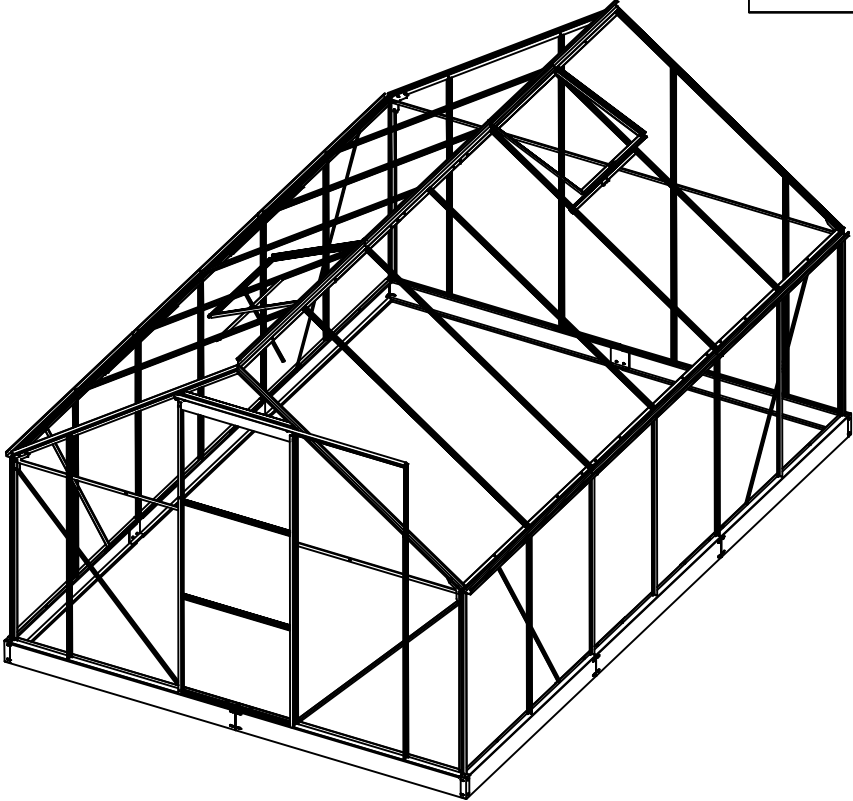
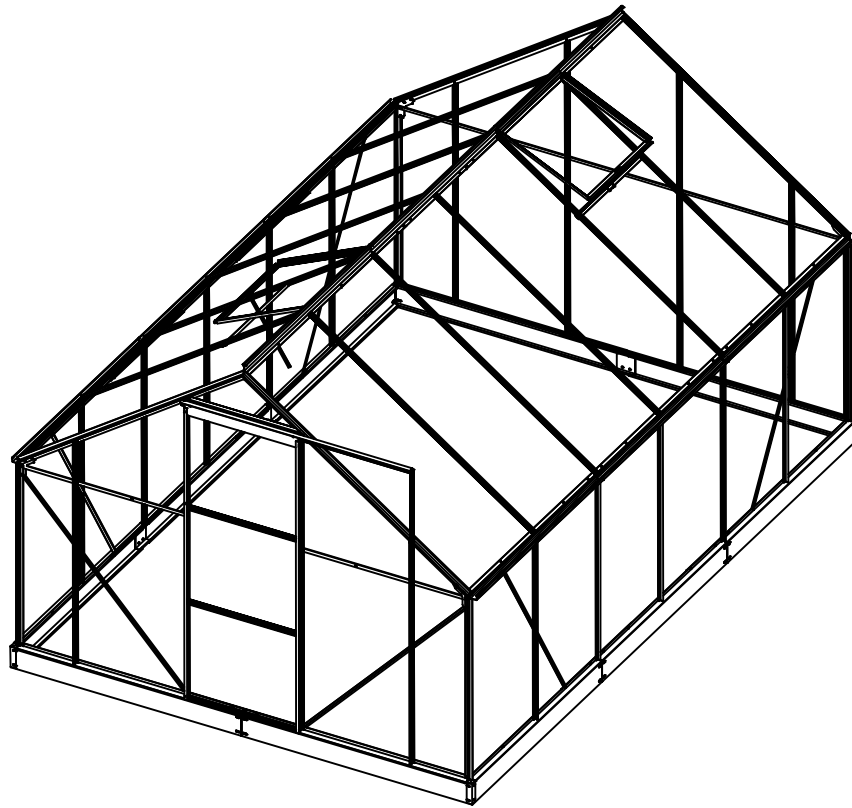
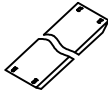

Bild	Nr.	Antal
	2	8
	2-1	2
	3	4
	29	6
	F3	40
	B2	26